

TCM 515Z – 2.4 GHZ IEEE 802.15.4 Transceiver

---

11 September 2017



Observe precautions! Electrostatic sensitive devices!

Patent protected:

WO98/36395, DE 100 25 561, DE 101 50 128,  
WO 2004/051591, DE 103 01 678 A1, DE 10309334,  
WO 04/109236, WO 05/096482, WO 02/095707,  
US 6,747,573, US 7,019,241

## TCM 515Z – 2.4 GHZ IEEE 802.15.4 Transceiver

**REVISION HISTORY**

The following major modifications and improvements have been made to this document:

Version	Author	Reviewer	Date	Major Changes
1.0	MKA	MK, MF	01.03.2016	Initial Release
1.1	MKA	MKA	01.05.2016	Added protocol description, changed location of TURBO Pin
1.2	MKA	MKA	19.07.2016	Added reflow profile
1.3	MKA	MKA	23.01.2017	Added list of supported ESP3 commands and minimum values for sensitivity and output power
1.4	MKA	MKA	13.02.2017	Added additional ESP3 interface speeds, added caution note regarding switching to TURBO mode via ESP3 command
1.5	MKA	MKA	12.06.2017	Added information about antenna options for US (FCC regulation)
1.6	DL	MKA	11.09.2017	Added information about FCC labelling requirements, RF exposure and distance requirements, FCC and ISED certificates

**Published by EnOcean GmbH, Kolpingring 18a, 82041 Oberhaching, Germany**  
**www.enocean.com, info@enocean.com, phone +49 (89) 6734 6890**

© EnOcean GmbH, All Rights Reserved

**Important!**

This information describes the type of component and shall not be considered as assured characteristics. No responsibility is assumed for possible omissions or inaccuracies. Circuitry and specifications are subject to change without notice. For the latest product specifications, refer to the EnOcean website: <http://www.enocean.com>.

As far as patents or other rights of third parties are concerned, liability is only assumed for modules, not for the described applications, processes and circuits.

EnOcean does not assume responsibility for use of modules described and limits its liability to the replacement of modules determined to be defective due to workmanship. Devices or systems containing RF components must meet the essential requirements of the local legal authorities.

The modules must not be used in any relation with equipment that supports, directly or indirectly, human health or life or with applications that can result in danger for people, animals or real value.

Components of the modules are considered and should be disposed of as hazardous waste. Local government regulations are to be observed.

Packing: Please use the recycling operators known to you.

## TCM 515Z – 2.4 GHZ IEEE 802.15.4 Transceiver

**TABLE OF CONTENT**

1	GENERAL DESCRIPTION .....	5
1.1	Basic functionality .....	5
1.2	Technical data.....	6
1.3	Physical dimensions.....	6
1.4	Environmental conditions .....	6
1.5	Packaging information.....	6
1.6	Ordering information.....	6
2	FUNCTIONAL INFORMATION .....	7
2.1	TCM 515Z Device Interface.....	7
2.1.1	Signal Description .....	8
2.2	High-level operation principle.....	8
2.3	Radio Functionality .....	9
2.3.1	Supported Radio Channels .....	9
2.3.2	Duty cycle limit .....	9
2.4	ESP3 Interface .....	10
2.4.1	ESP3 Data Format.....	10
2.4.2	Supported ESP3 Commands.....	10
3	Antenna options .....	11
3.1	General antenna requirements for TCM 515Z .....	11
3.2	Specific antenna requirements for European Union .....	11
3.3	Specific antenna requirements for US / Canada.....	11
3.4	Antenna description .....	12
3.4.1	Whip antenna.....	12
3.4.2	Meandered PCB antenna.....	13
3.4.3	Dipole antenna requirements .....	15
3.4.4	Dipole antenna options.....	18
4	Device Integration.....	19
4.1	Recommended PCB Footprint .....	19
4.2	Soldering information.....	20
4.3	Device handling instructions .....	21
4.4	Tape & Reel specification.....	22
4.5	Power supply requirements.....	23
5	APPLICATION INFORMATION .....	24
5.1	Transmission range .....	24
6	REGULATORY INFORMATION.....	25
6.1	CE (RED) for European Union.....	25
6.2	FCC (United States) Certificate.....	26
6.2.1	FCC (United States) regulatory statement.....	27
6.2.2	FCC (United States) labeling requirements.....	27
6.2.3	FCC (United States) RF exposure statement.....	27
6.3	ISED (Industry Canada) Technical Acceptance Certificate .....	28

TCM 515Z – 2.4 GHZ IEEE 802.15.4 Transceiver

---

6.3.1	ISED (Industry Canada) regulatory statement .....	29
6.3.2	IC (Industry Canada) RF exposure statement .....	29
Appendix A	IEEE 802.15.4 Frame Structure .....	30
A.1	IEEE 802.15.4 High Level Frame Structure .....	30
A.2	PHY Header .....	31
A.2.1	Length of Frame values used by PTM 215ZE and PTM 535Z .....	31
A.3	MAC Header.....	32
A.4	MAC Payload.....	32
A.5	MAC Trailer.....	32
Appendix B	MAC Payload Structure .....	33
B.1	Secure data telegram format (with authentication) .....	34
B.2	Secure commissioning telegram format (with authentication) .....	35
B.3	Standard data telegram format (without authentication) .....	36
B.4	Standard commissioning telegram (without authentication) .....	37
Appendix C	ESP3 Interface Format .....	38
C.1	Packet Type 0x10: IEEE 802.15.4 Raw Packet.....	38
C.1.1	ESP3 packet structure for IEEE 802.15.4 Raw Packets.....	38
C.1.2	RESPONSE for IEEE 802.15.4 Raw Packets .....	39
C.1.3	Failure Indication for IEEE 802.15.4 Raw Packet.....	40
C.2	Packet Type 0x11: IEEE 802.15.4 COMMAND.....	41
C.2.1	Packet structure for IEEE 802.15.4 COMMAND .....	41
C.2.2	List of supported commands .....	41
C.2.3	SET_CHANNEL Command .....	42
C.2.4	RESPONSE for SET_CHANNEL Command .....	42
C.2.5	GET_CHANNEL Command.....	43
C.2.6	RESPONSE for GET_CHANNEL Command.....	43
C.3	Packet Type Common Command .....	44
C.3.1	Command Code 0x24: CO_SET_BAUDRATE .....	44
C.3.2	RESPONSE for CO_SET_BAUDRATE Command .....	44
C.3.3	Command Code 0x25: CO_GET_FREQUENCY_INFO .....	45
C.3.4	RESPONSE for CO_GET_FREQUENCY_INFO Command.....	45
C.3.5	Command Code 37: CO_GET_STEPCODE.....	46
C.3.6	RESPONSE for CO_GET_STEPCODE Command .....	46

## TCM 515Z – 2.4 GHZ IEEE 802.15.4 Transceiver

## 1 GENERAL DESCRIPTION

### 1.1 Basic functionality

TCM 515Z enables the realization of line-powered actuators, controllers and gateways communicating based on the 2.4 GHz IEEE 802.15.4 radio standard. It provides a transparent radio link between EnOcean 2.4 GHz devices and an external host connected via the standardized ESP3 interface (EnOcean Serial Protocol, version 3).

TCM 515Z receives and transmits radio telegrams based on a 50 Ohm or whip antenna connected to the host PCB. It forwards received 2.4 GHz IEEE 802.15.4 radio telegrams to an external host processor or host PC via the ESP3 interface.

IEEE 802.15.4 messages received from an external host via the ESP3 interface will be transmitted by TCM 515Z as 2.4 GHz radio telegrams.

TCM 515Z is implemented as 31 pin reflow-solderable module with optimized form factor for size constrained applications.

Figure 1 below shows TCM 515Z.



**Figure 1 – TCM 515Z outline**

## TCM 515Z – 2.4 GHZ IEEE 802.15.4 Transceiver

## 1.2 Technical data

<b>Antenna</b>	External 50 Ohm or whip antenna (connected at host board)
<b>Supported Radio Frequency Range</b>	Radio channel 11 ... 26 according to IEEE 802.15.4 standard
<b>Default Radio Channel</b>	IEEE 802.15.4 radio channel 11
<b>Receiver Sensitivity (at 25°C)<sup>(1)</sup></b>	Minimum: -92dBm / Typical: -95 dBm
<b>Transmit Power (at 25°C)</b>	Minimum: 0dBm / Typical: +2 dBm
<b>Power Supply</b>	3.3 V +- 10%
<b>Serial Host Interface</b>	UART according to ESP3 Standard with Turbo Mode Option
<b>Current Consumption (typ, at 25°C)</b>	Transmit: 20mA, Receive: 15 mA
<b>Radio Regulation</b>	R&TTE (Europe), FCC (US), IC (Canada)

Note (1): Receiver sensitivity is based on the combination of 3 subtelegrams

## 1.3 Physical dimensions

<b>Module Dimensions</b>	19.0 x 14.7 x 3.0 mm (each dimension +-0.3 mm)
<b>Module Weight</b>	1 g

## 1.4 Environmental conditions

<b>Operating Temperature</b>	-25°C ... 85°C
<b>Storage Temperature</b>	-25°C ... 85°C
<b>Humidity</b>	0% to 95% r.h. (non-condensing)

## 1.5 Packaging information

<b>Packaging Unit</b>	250 units
<b>Packaging Method</b>	Tape and reel

## 1.6 Ordering information

Type	Ordering Code	Frequency
TCM 515Z	S3073-K515	2.4 GHz (IEEE 802.15.4)

TCM 515Z – 2.4 GHZ IEEE 802.15.4 Transceiver

## 2 FUNCTIONAL INFORMATION

### 2.1 TCM 515Z Device Interface

TCM 515Z implements a 31 pin reflow-solderable interface. Solder mask data is available on request from EnOcean. The pin assignment (as seen from the top of the device) is shown in Figure 2 below.

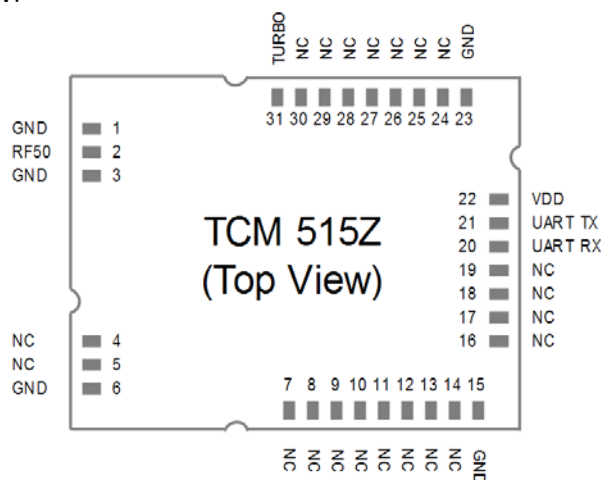

**Figure 2 – TCM 515Z device interface**

Table 1 below summarizes the signal assignment.

PIN	NAME	PIN	NAME	PIN	NAME
1	GND	12	NC	23	GND
2	ANTENNA (50 Ohms)	13	NC	24	NC
3	GND	14	NC	25	NC
4	NC	15	GND	26	NC
5	NC	16	NC	27	NC
6	GND	17	NC	28	NC
7	NC	18	NC	29	NC
8	NC	19	NC	30	NC
9	NC	20	UART_RX (Input)	31	TURBO
10	NC	21	UART_TX (Output)		
11	NC	22	VDD		

**Table 1 - TCM 515Z device interface pin assignment**

Signals marked with "NC" are reserved for production test and future device variants and must not be connected in the design.

## TCM 515Z – 2.4 GHZ IEEE 802.15.4 Transceiver

---

### 2.1.1 Signal Description

TCM 515Z is supplied by the VDD and GND Pins. The required supply voltage is 3.3V with a tolerance of no more than  $\pm 10\%$ .

TCM 515Z receives and transmits data based on a  $50\Omega$  whip antenna connected to its ANTENNA input (Pin 2).

TCM 515Z communicates with the external host using the standard ESP3 serial (UART) interface based on the signals UART\_TX (Pin 21, direction from TCM 515Z to external host) and UART\_RX (Pin 20, direction from external host to TCM 51Z).

The default interface speed of the ESP3 interface is 57600 bit per second (the exact speed is 57347 Bit per second, a deviation of  $-0.04\%$ ).

It is possible to select faster communication speeds of 115200, 230400 and 460800 bit per second during operation using the CO\_SET\_BAUDRATE command as shown in Table 15.

Additionally it is possible to change the default ESP3 interface speed at power up from 57.600 Bit per second to 460.800 Bit per second by connecting the TURBO input (Pin 31) to Ground. Subsequent modification of the interface speed during operation using the CO\_SET\_BAUDRATE command is always possible irrespective of the state of the TURBO input pin.

## 2.2 High-level operation principle

In receive mode, TCM 515Z forwards the content of received IEEE 802.15.4 radio telegrams (which pass frame check sum validation) unmodified to the external host via the ESP3 interface.

The forwarded frame starts with the *Length* field of the IEEE 802.15.4 PHY Header, continues with the MAC Header and ends with the last Byte of the MAC Payload. The frame check sum (MAC Trailer) will not be forwarded to the host.

In transmit mode, TCM 515Z receives from the external host the precomputed message payload starting with the *Length* field of the IEEE 802.15.4 PHY Header, continuing with the MAC Header and ending with the last Byte of the MAC Payload.

TCM 515Z then calculates the frame check sum (MAC Trailer) and appends it to the message. The full frame (including the Preamble and Start of Frame fields) will then be transmitted as IEEE 802.15.4 radio telegram (TX mode).



## TCM 515Z – 2.4 GHZ IEEE 802.15.4 Transceiver

---

### 2.3 Radio Functionality

#### 2.3.1 Supported Radio Channels

TCM 515Z support all radio channels of the IEEE 802.15.4 standard in the 2.4 GHz band. The radio channel used by TCM 515Z can be set by an external host using the ESP3 SET\_CHANNEL command as described in Appendix C.2.3.

The channel notation used by TCM 515Z follows IEEE 802.15.4 standard, i.e. channel 11 is the first channel (lowest frequency) and channel 26 is the last channel (highest frequency). Table 2 below shows the correspondence between channel ID and channel frequency.

Channel ID	Lower Frequency	Centre Frequency	Upper Frequency
11	2404	2405	2406
12	2409	2410	2411
13	2414	2415	2416
14	2419	2420	2421
15	2424	2425	2426
16	2429	2430	2431
17	2434	2435	2436
18	2439	2440	2441
19	2444	2445	2446
20	2449	2450	2451
21	2454	2455	2456
22	2459	2460	2461
23	2464	2465	2466
24	2469	2470	2471
25	2474	2475	2476
26	2479	2480	2481

**Table 2 - Supported radio channels**

#### 2.3.2 Duty cycle limit

In order to ensure regulatory compliance in some markets, the transmission duty cycle of TCM 515Z may not exceed 35%. An internal SW mechanism therefore monitors the duty cycle and will temporarily reject requests for additional transmissions if this duty cycle is exceeded (note: this is only possible if TURBO mode is used and the host continuously requests transmission).

It is the responsibility of the end user to design the host system such that either such temporary transmission suspension does not affect the intended application functionality or to ensure that the transmission duty cycle requested by the host will not exceed 35%.

## TCM 515Z – 2.4 GHZ IEEE 802.15.4 Transceiver

---

### 2.4 ESP3 Interface

TCM 515Z provides a bi-directional UART interface for communicating with the external host. The default baud rate of this interface is 57600 bps. If the TURBO pin is set to active low then the baud rate is increased to 460.800 bps.

#### 2.4.1 ESP3 Data Format

TCM 515Z communicate with external hosts using EnOcean Serial Protocol version 3 (ESP3) with EnOcean 2.4 GHz IEEE 802.15.4 extensions.

Please consult the detailed ESP3 specification at <https://www.enocean.com/esp>.

#### 2.4.2 Supported ESP3 Commands

TCM 515Z supports the following ESP3 commands:

- Packet Type 0x10: IEEE 802.15.4 Raw Packet
- Packet Type 0x11: IEEE 802.15.4 COMMAND
  - SET\_CHANNEL
  - GET\_CHANNEL
- Packet Type 0x05: Common Command
  - CO\_SET\_BAUDRATE
  - CO\_GET\_FREQUENCY\_INFO
  - CO\_GET\_STEP CODE

Please refer to Appendix C for a description of the supported commands.

TCM 515Z – 2.4 GHZ IEEE 802.15.4 Transceiver

---

### 3 Antenna options

This chapter outlines options for antenna that can be used with TCM 515Z. Note that this chapter is for guidance purposes only, please consult with an authorized certification body for specific information.

#### 3.1 General antenna requirements for TCM 515Z

Antenna used with TCM 515Z shall always meet the requirements listed in Table 3 below.

Frequency Band	2.45GHz ISM
Antenna Type	Passive
Impedance	50Ω, VSWR≤3
Maximum Gain	≤6dBi

**Table 3 – General antenna requirements**

#### 3.2 Specific antenna requirements for European Union

TCM 515Z can be used with the antennas described in subsequent chapters.

See chapter 6.1 for additional important remarks regarding RED certification.

#### 3.3 Specific antenna requirements for US / Canada

The TCM 515Z has been tested and certified according to FCC regulation with a number of different antennas as described below.

TCM 515Z – 2.4 GHZ IEEE 802.15.4 Transceiver

### 3.4 Antenna description

The TCM 515Z has been tested and certified according to FCC regulation with a number of different antennas as described below.

#### 3.4.1 Whip antenna

TCM 515Z modules can be used with a whip antenna meeting key parameters shown in Figure 3 below.

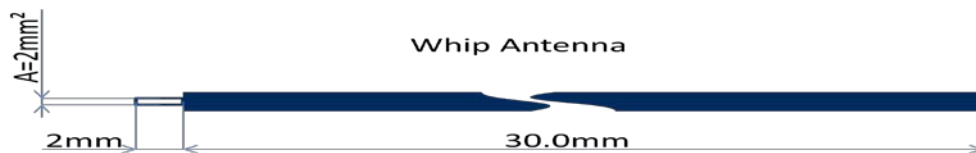
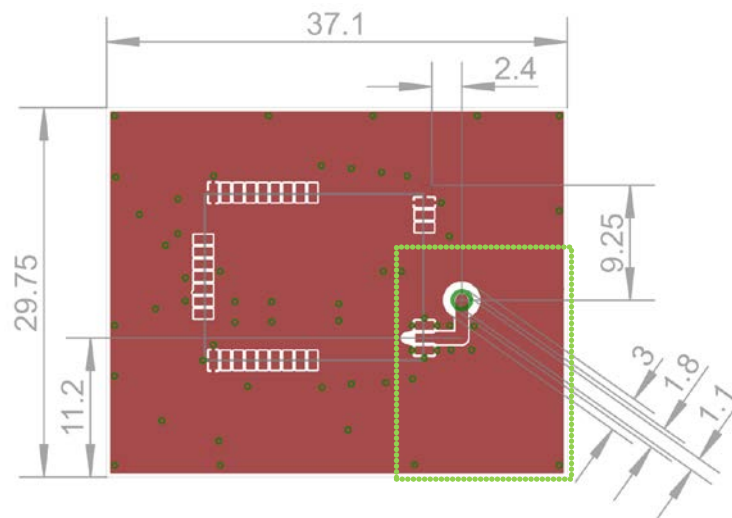

**Figure 3 – Whip antenna parameters for 2.4 GHz**

The whip antenna has to meet the following parameters:

- Antenna length (L): 30 mm wire, connect to RF\_WHIP
- Minimum GND plane: 15 mm x 15 mm
- Minimum distance space: 10 mm

The reference layout for this antenna is shown in Figure 4 below. The area within the green dotted rectangle and the minimum ground plane has to be implemented exactly as shown in order to use EnOcean modular approval for US / Canada.



**Figure 4 – Whip antenna reference layout**

TCM 515Z – 2.4 GHZ IEEE 802.15.4 Transceiver

Additionally, the transmission line between TCM 515Z and the whip antenna has to be implemented as specified in Figure 5 below in order to use EnOcean modular approval for US / Canada.

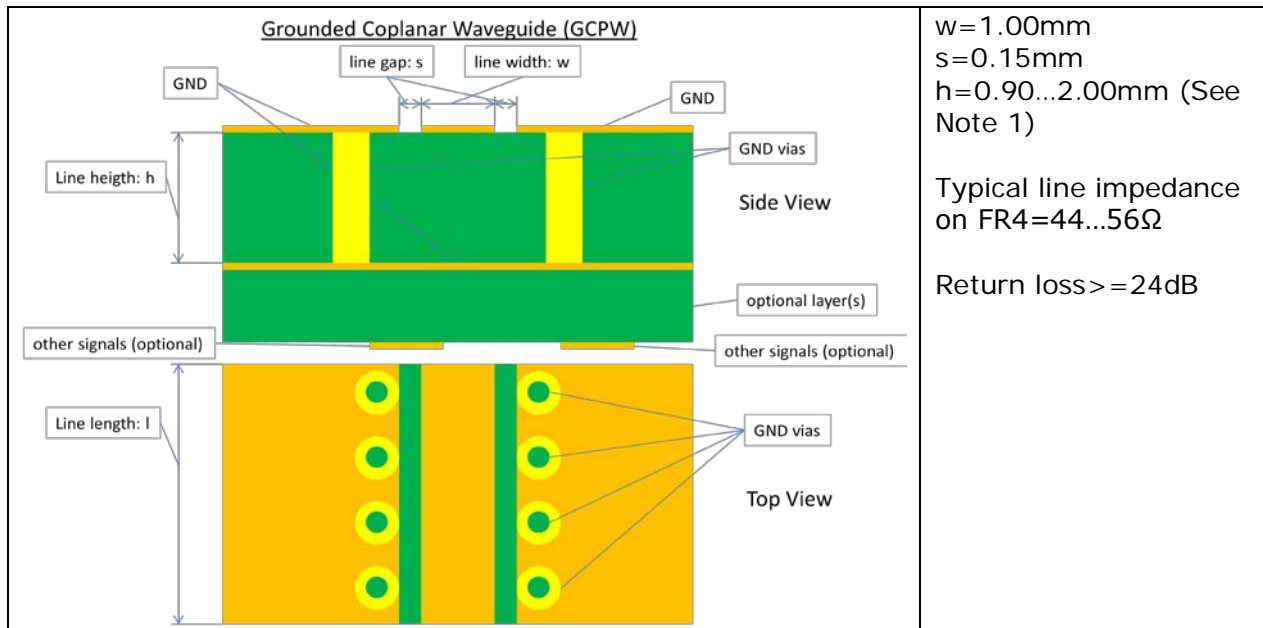

**Figure 5 – Transmission line specification**

Note (1): Coplanar waveguide modes are dominant in this configuration. Thus thickness of substrate can be changed with the given limits.

### 3.4.2 Meandered PCB antenna

TCM 515Z has been certified for use with a meandered PCB antenna provided that the following layout guidelines are met:

- Matching circuit values of the modular approval may not be changed
- Shape according to reference layout in Figure 6
- Minimum GND plane: 40 mm x 18 mm
- Connect GND planes using multiple via as shown in Figure 6
- Minimum distance space: 10 mm
- Matching circuit components as specified in Table 4

TCM 515Z – 2.4 GHZ IEEE 802.15.4 Transceiver

Figure 6 below shows the dimensions of the meandered PCB antenna, the matching circuit and the area important for US / Canada modular approval (marked in green).

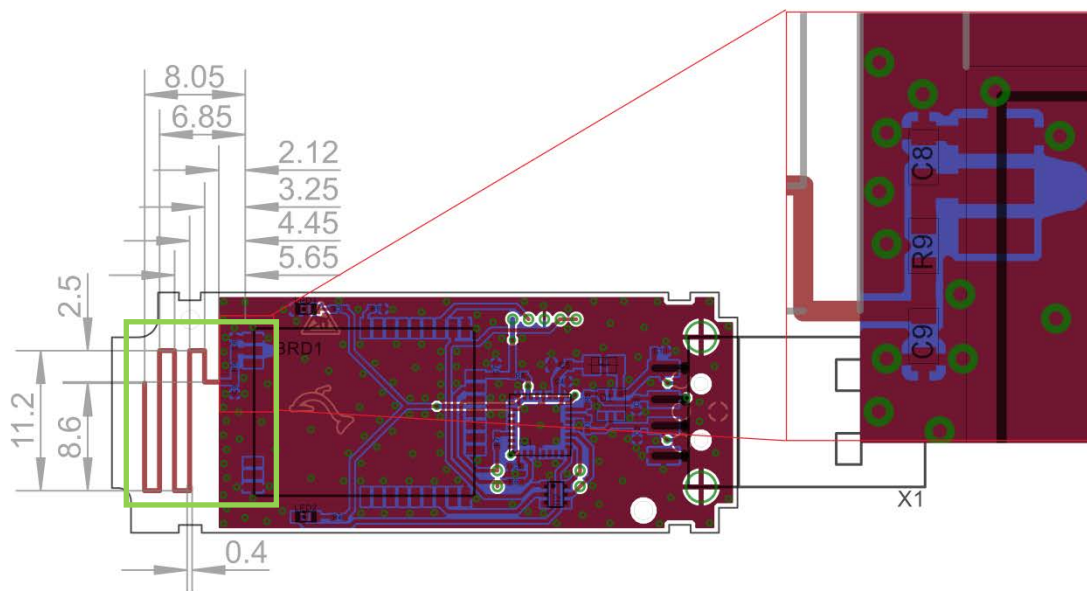

**Figure 6 – Reference layout for meandered PCB antenna**

Table 4 below lists the parameters of the matching circuit components. It is mandatory to use them as specified for US / Canada modular approval usage.

Designator	Value	Notes
C8	1.0pF	Use Murata GRM1555 series or similar
R9	6.8nH	Use Würth WE-KI series, Murata LQW series or similar
C9	---	Not assembled

**Table 4 – Parameters of the matching circuit**

TCM 515Z – 2.4 GHZ IEEE 802.15.4 Transceiver

### 3.4.3 Dipole antenna requirements

The TCM 515Z has been certified for use with the dipole antenna S151AH-2450S from Nearson or other antennas with similar parameters provided that:

- The RF connector is a non-standard connector such as a RP-SMA-Female from Johnson/Cinch Connectivity Solutions (142-4701-801)
- The pi low pass filter described in this section is used

In addition, the following layout guidelines have to be met:

- The pi low pass filter is part of the modular approval and may not be changed
- The bottom GND plane is implemented below the RF transmission line section of the circuit to form a grounded coplanar waveguide (see Figure 8)
- The ground planes have to be connected using multiple via along RF transmission line as shown in Figure 7 and Figure 8

Table 6 at the end of this section lists dipole antennas that can be used instead of the S151AH-2450S antenna stated previously as they are the same kind of antennas and have the same or less gain.

Figure 7 below shows the layout that has been used. The section of the layout located within the green frame has to remain unchanged for US / Canada modular approval usage.

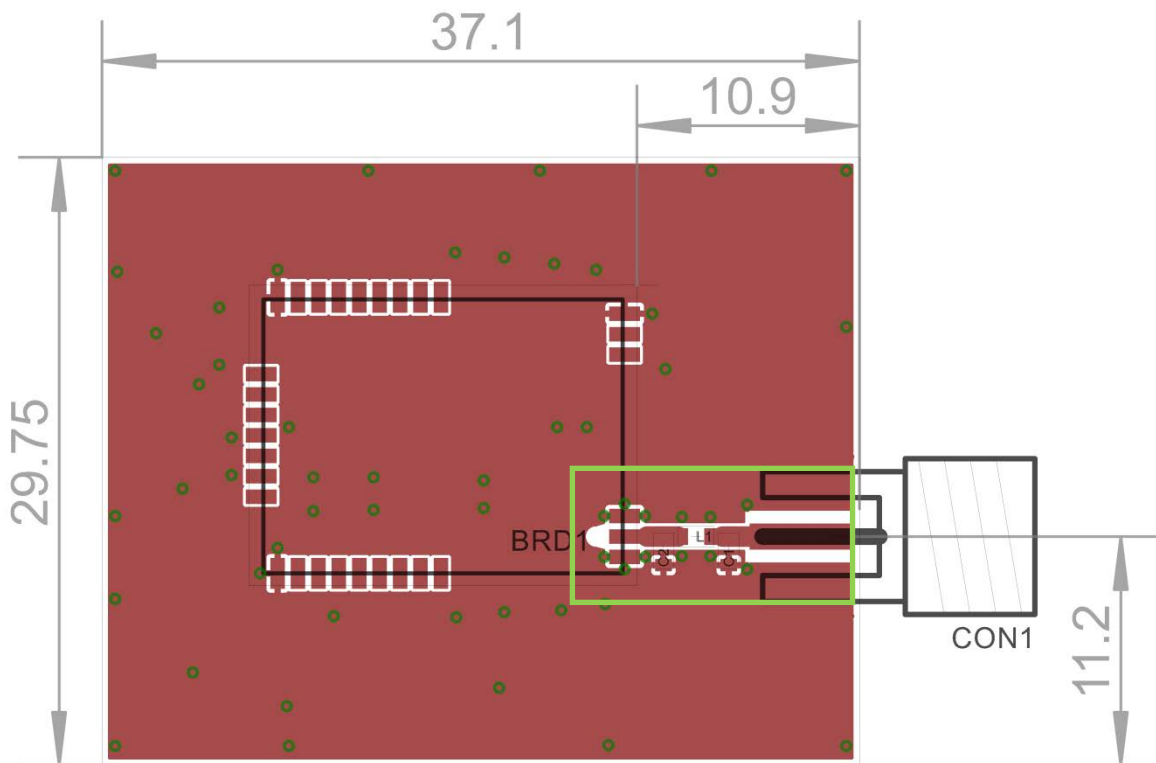

**Figure 7 – Reference layout for dipole antenna**

TCM 515Z – 2.4 GHZ IEEE 802.15.4 Transceiver

Table 5 below lists the parameters of the components which have to be used for the pi low pass filter.

Designator	Value	Notes
C1	1.0pF	use Murata GRM1555 series or similar
C2	1.0pF	use Murata GRM1555 series or similar
L1	3.1nH	use Murata LQP15MN series or similar

**Table 5 – Values of the pi low pass filter for the dipole antenna**

The transmission line between TCM 515Z and the antenna has to be implemented as shown in Figure 8 below.

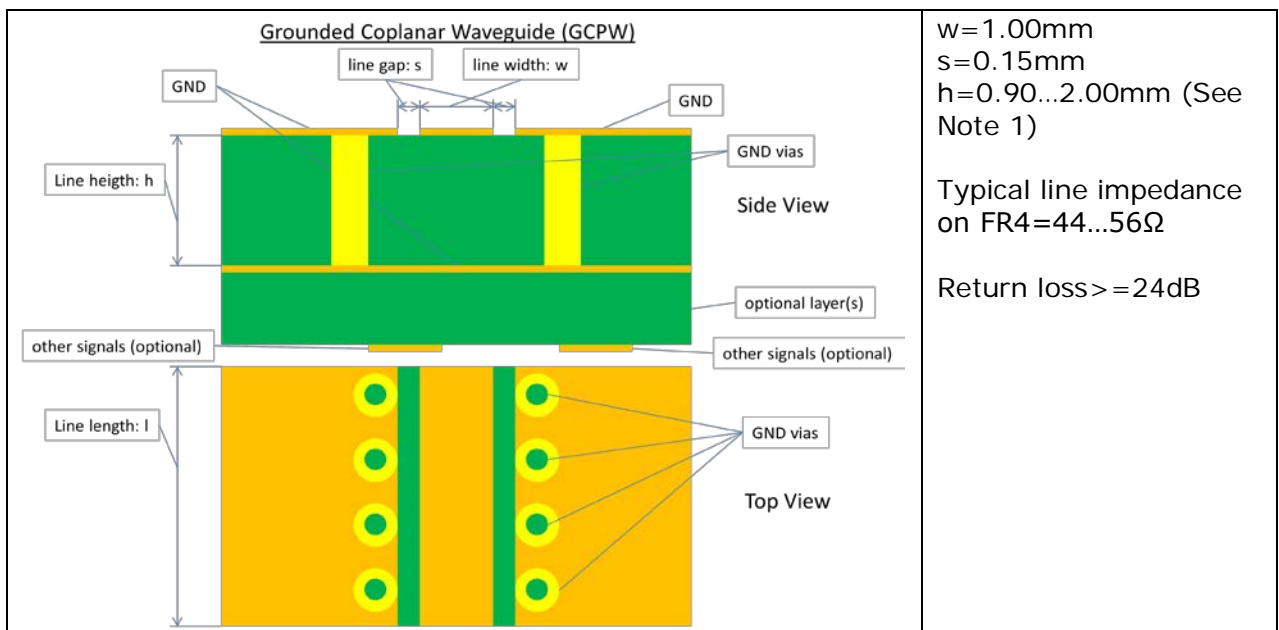

**Figure 8 – Detailed description of RF transmission line**

Note (1): Coplanar waveguide modes are dominant in this configuration. Thus thickness of substrate can be changed with the given limits.



TCM 515Z – 2.4 GHZ IEEE 802.15.4 Transceiver

Figure 9 below shows S151AH-2450S from Nearson.

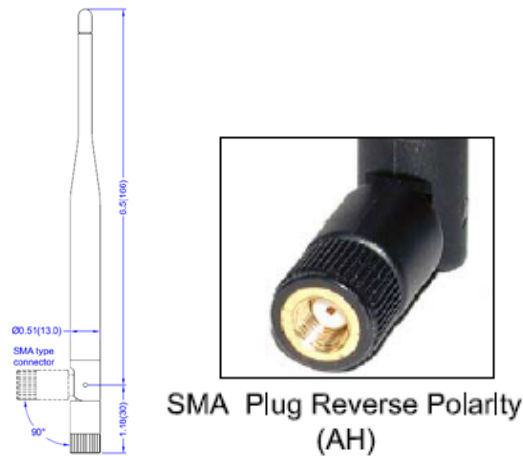

**Figure 9 - S151AH-2450S**

Figure 10 below shows the RP-SMA-Female (142-4701-801) from Chinch Connectivity Solutions as an example for a non-standard RF connector required for US / Canada modular approval usage.

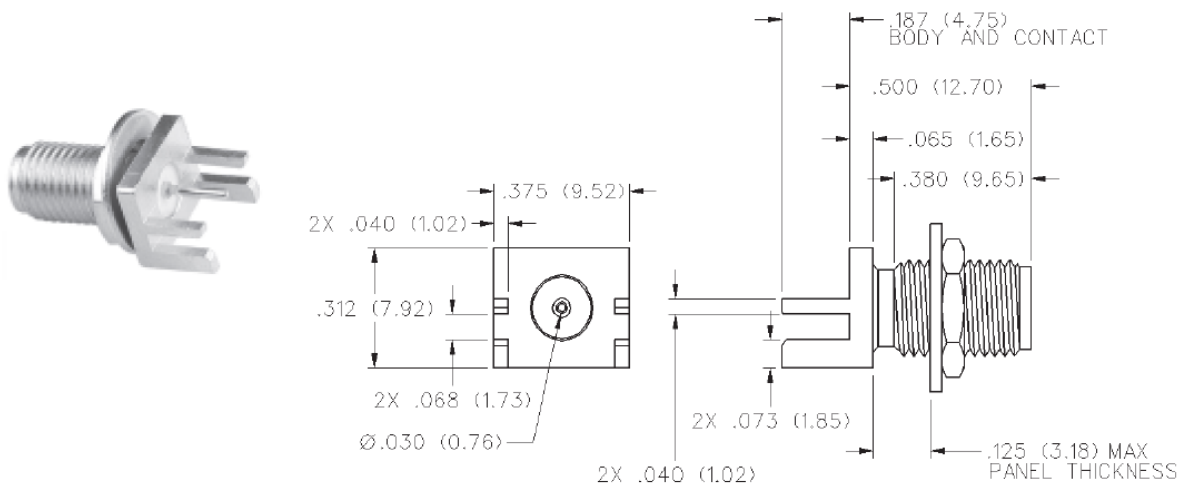

**Figure 10 – RP-SMA-Female**

## TCM 515Z – 2.4 GHZ IEEE 802.15.4 Transceiver

### 3.4.4 Dipole antenna options

Table 6 below shows examples of dipole antennas that could be used with TCM 5151Z under US / Canada modular approval.

Manufacturer	Manufacturer Part Number	Gain	Antenna Type
Nearson Inc. <sup>1</sup>	S151AH-2450S	5dBi	Whip (Dipole), Tilt
Nearson Inc.	S131AH-2450S	5dBi	Whip (Dipole), Tilt
Nearson Inc.	S181AH-2450S	2dBi	Whip (Dipole), Tilt
ATOP Technologies	ANT-WS-AB-RM-05-200	5dBi	Whip (Dipole), Straight
ATOP Technologies	ANT-WS-AB-RM-05-180	5dBi	Whip (Dipole), Straight
Digi International	A24-HASM-525	2.1dBi	Whip (Dipole), Tilt
Digi International	A24-HASM-450	2.1dBi	Whip (Dipole), Tilt
Digi International	DG-ANT-20DP-BG	2dBi	Whip (Dipole), Tilt
Digi International	DC-ANT-24DP	1.8dBi	Whip (Dipole), Tilt
Digi International	DC-ANT-24DT	1.8dBi	Whip (Dipole), Straight
Honeywell	WAN01RSP	2.2dBi	Whip (Dipole), Straight
Honeywell	WAN02RSP	2.2dBi	Whip (Dipole), Tilt
Laird Technologies IAS	S2403BH36RSM	3dBi	Whip (Dipole), Straight
Laird Technologies IAS	EXR2400RSM	3dBi	Whip (Dipole), Tilt
Laird Technologies IAS	MAF94046	1.3dBi	Whip (Dipole), Tilt
Laird Technologies IAS	MAF94028	1.3dBi	Whip (Dipole), Tilt
Laird Technologies IAS	MAF94112	1.5dBi	Whip (Dipole), Tilt
Linx Technologies Inc.	ANT-2.4-CW-HW	3.2dBi	Whip (Dipole), Straight
Linx Technologies Inc.	ANT-2.4-CW-RCT-RP	2.2dBi	Whip (Dipole), Tilt
Linx Technologies Inc.	ANT-2.4-CW-HWR-RPS	3.2dBi	Whip (Dipole), Tilt
Linx Technologies Inc.	ANT-2.4-CW-CT-RPS	2.8dBi	Whip (Dipole), Straight
LSR	001-0010	2dBi	Whip (Dipole), Tilt
LSR	001-0001	2dBi	Whip (Dipole), Tilt
Microchip Technology	RN-SMA4-RP	2.2dBi	Whip (Dipole), Tilt
Proant AB	333	3dBi	Whip (Dipole), Tilt
Proant AB	348	3dBi	Whip (Dipole), Straight
Pulse Electronics	W1037	3.2dBi	Whip (Dipole), Tilt
Pulse Electronics	W1027	3.2dBi	Whip (Dipole), Tilt
Pulse Electronics	W1030	2dBi	Whip (Dipole), Tilt
Pulse Electronics	W5010	1.5dBi	Whip (Dipole), Straight
Pulse Electronics	W5001	1.5dBi	Whip (Dipole), Right Angle
Red Lion Controls	ANT-GW11A153	2.3dBi	Whip (Dipole), Tilt
Siretta Ltd	DELTA6B/X/SMAM/RP/S/11	5dBi	Whip (Dipole), Tilt
Siretta Ltd	DELTA10A/X/SMAM/RP/S/17	3dBi	Whip (Dipole), Straight
Taoglas Limited	GW.11.A153	2.3dBi	Whip (Dipole), Tilt
Taoglas Limited	GW.26.0151	1.8dBi	Whip (Dipole), Straight
Walsin Technology	RFDPA151300SBAB8G1	3dBi	Whip (Dipole), Tilt
Walsin Technology	RFDPA171300SBAB8G1	3dBi	Whip (Dipole), Tilt
Walsin Technology	RFDPA870900SBAB8G1	2dBi	Whip (Dipole), Tilt

**Table 6 – Dipole antenna options**

<sup>1</sup> This antenna was tested for FCC and IC certification

TCM 515Z – 2.4 GHZ IEEE 802.15.4 Transceiver

## 4 Device Integration

TCM 515Z is designed for integration onto a host PCB. Detailed Gerber data of the device footprint is available from EnOcean upon request.

### 4.1 Recommended PCB Footprint

Figure 11 below shows the recommended PCB footprint for TCM 515Z.

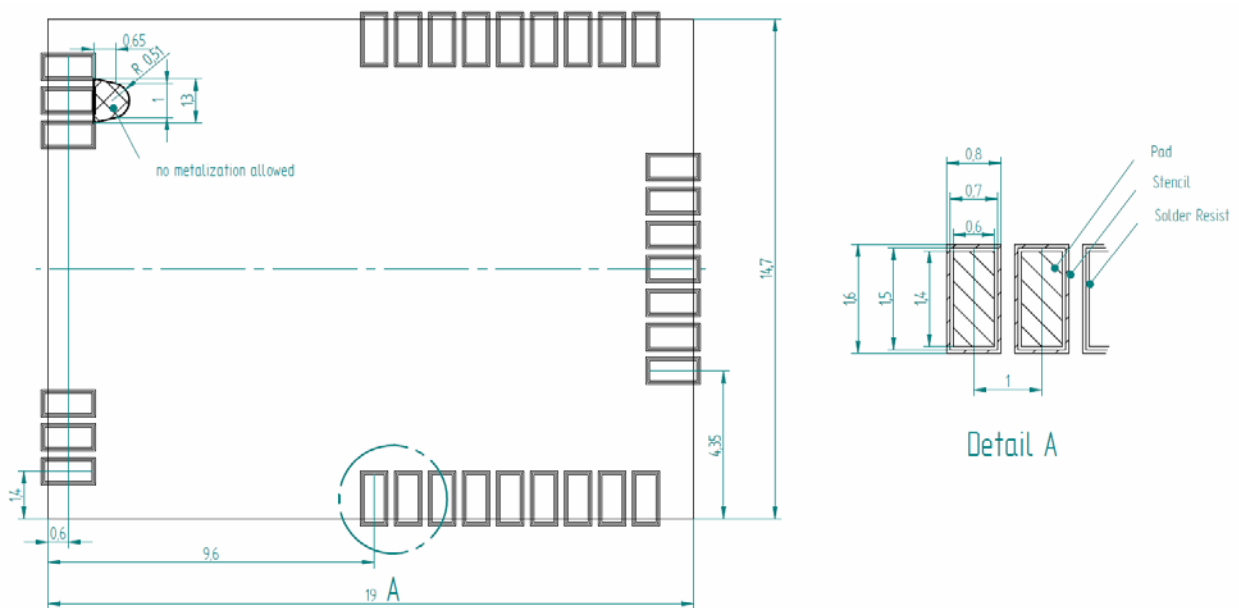

**Figure 11 – Recommended PCB footprint**

TCM 515Z – 2.4 GHZ IEEE 802.15.4 Transceiver

### 4.2 Soldering information

TCM 515Z has to be soldered according to IPC/JEDEC J-STD-020C standard as outlined in Figure 12 below.

Profile Feature	Pb-Free Assembly
Average Ramp-Up Rate (T <sub>smax</sub> to T <sub>p</sub> )	3° C/second max.
<b>Preheat</b> – Temperature Min (T <sub>smin</sub> ) – Temperature Max (T <sub>smax</sub> ) – Time (t <sub>smin</sub> to t <sub>smax</sub> )	150 °C 200 °C 60-180 seconds
Time maintained above: – Temperature (T <sub>L</sub> ) – Time (t <sub>L</sub> )	217 °C 60-150 seconds
Peak/Classification Temperature (T <sub>p</sub> )	260 °C
Time within 5 °C of actual Peak Temperature (t <sub>p</sub> )	20-40 seconds
Ramp-Down Rate	6 °C/second max.
Time 25 °C to Peak Temperature	8 minutes max.

Note 1: All temperatures refer to topside of the package, measured on the package body surface.

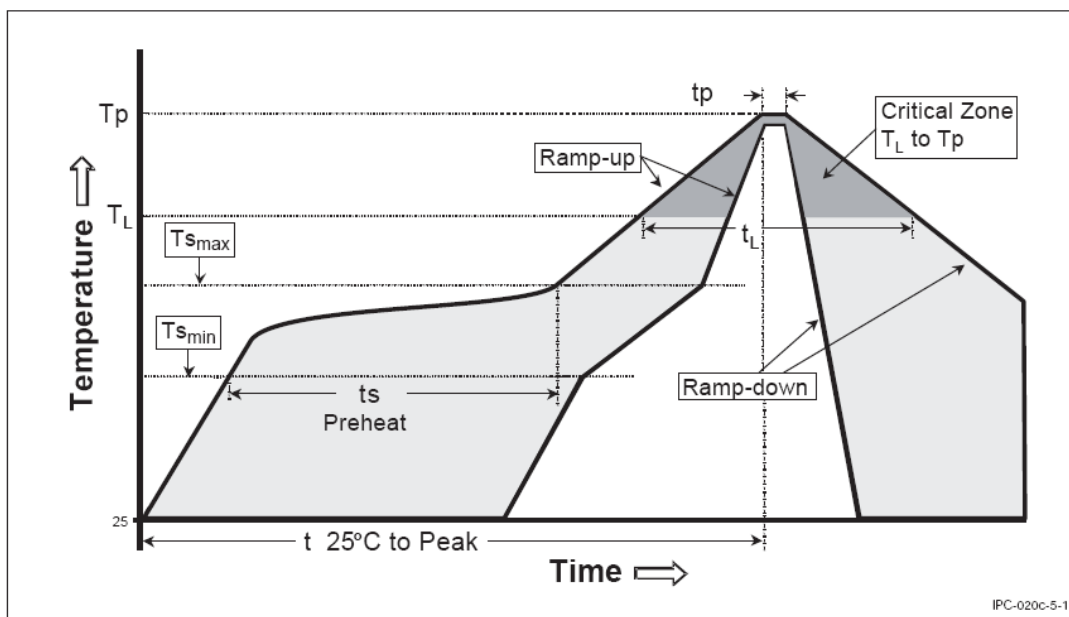

Figure 12 – Recommended temperature profile

### 4.3 Device handling instructions

TCM 515Z shall be handled according to Moisture Sensitivity Level MSL 3. TCM 515Z may be soldered only once, since one time is already consumed at production of the module itself.

Once the dry pack bag is opened, the desired quantity of units should be removed and the bag resealed within two hours. If the bag is left open longer than 30 minutes the desiccant should be replaced with dry desiccant. If devices have exceeded the specified floor life time of 168 h, they may be baked according IPC/JEDEC J-STD-033B at max. 90 °C for less than 60 hours.

Devices packaged in moisture-proof packaging should be stored in ambient conditions not exceeding temperatures of 40 °C or humidity levels of 90% r.H.

TCM 515Z modules have to be soldered within 6 months after delivery!

In general we recommend a no clean flux process. If washing is needed, then TCM 515Z radio modules have a shield cover with small openings at the top of the edges.

It is very important to mount the modules in a top down position during the drying process as this will allow getting the aggregated washing fluid removed properly from within the shield cover area.

To prevent damage, modules have to be checked for any remaining fluid after the drying.

TCM 515Z – 2.4 GHZ IEEE 802.15.4 Transceiver

### 4.4 Tape & Reel specification

TCM 515Z is delivered in Tape & Reel packaging with 250 units per reel. Figure 13 below illustrates the dimensions.

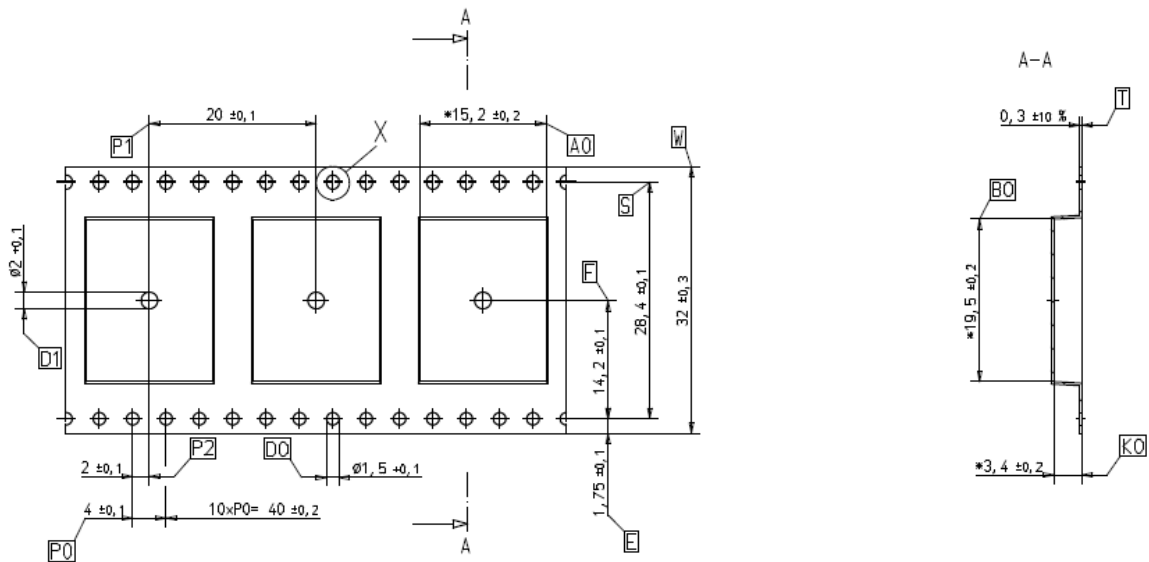

Figure 13 – Tape & Reel dimensions of TCM 515Z

Figure 14 below shows the positioning of TCM 515Z in the Tape & Reel packaging.

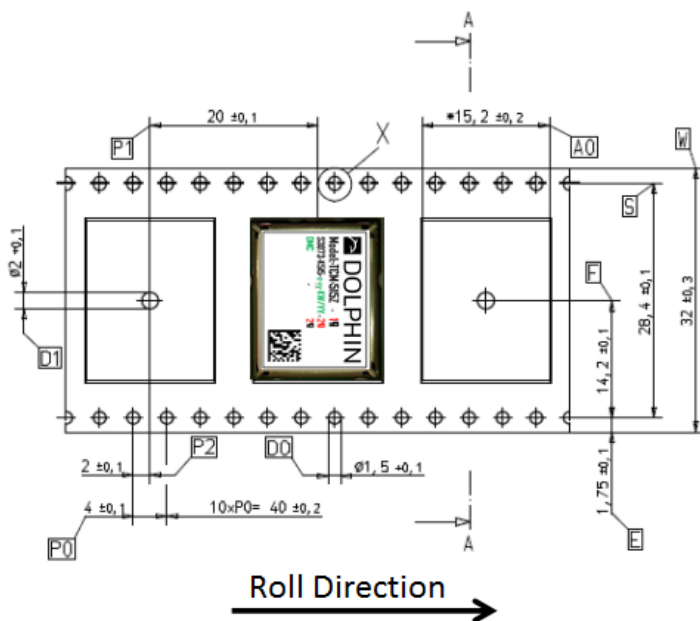

Figure 14 – Position of TCM 515Z in the reel

## 4.5 Power supply requirements

In order to provide a good radio performance, great attention must be paid to the power supply and a correct layout and shielding. It is recommended to place a 22  $\mu$ F ceramic capacitor between VDD and GND close to the module (material: X5R, X7R, min 6.3 V to avoid derating effects).

In addition, an HF SMD EMI Suppression Ferrite Bead such as the Würth WE-CBF HF SMD EMI Suppression Ferrite Bead (Würth order number 742863160) shall be inserted in the power supply line.

For best performance it is recommended to keep the ripple on the power supply rail below 10 mVpp.

TCM 515Z integrates approximately 10  $\mu$ F of capacitance for filtering the internal supply voltage bus. The power supply architecture has to be capable of supplying sufficient current to charge this capacitance during power up.

## 5 APPLICATION INFORMATION

### 5.1 Transmission range

The main factors that influence the system transmission range are:

- Type and location of the antennas of receiver and transmitter
- Type of terrain and degree of obstruction of the link path
- Sources of interference affecting the receiver
- "Dead spots" caused by signal reflections from nearby conductive objects.

Since the expected transmission range strongly depends on this system conditions, range tests should always be performed to determine the reliably achievable range under the given conditions.

The following figures should be treated as a rough guide only:

- Line-of-sight connections  
Typically 15 m range in corridors, up to 50 m in halls
- Plasterboard walls / dry wood  
Typically 15 m range, through max. 2 walls
- Ferro concrete walls / ceilings  
Maximum 1 wall or ceiling, depending on thickness and material
- Fire-safety walls, elevator shafts, staircases and similar areas should be considered as shielded

The angle at which the transmitted signal hits the wall is very important. The effective wall thickness – and with it the signal attenuation – varies according to this angle. Signals should be transmitted as directly as possible through the wall. Wall niches should be avoided.

Other factors restricting transmission range include:

- Switch mounting on metal surfaces (up to 30% loss of transmission range)
- Hollow lightweight walls filled with insulating wool on metal foil
- False ceilings with panels of metal or carbon fibre
- Lead glass or glass with metal coating, steel furniture

The distance between the receiver and other transmitting devices such as computers, audio and video equipment that also emit high-frequency signals should be at least 0.5 m.



## 6 REGULATORY INFORMATION

TCM 515Z has been certified according to FCC, IC and CE regulations. Changes or modifications not expressly approved by EnOcean could void the user's authority to operate the equipment.

### 6.1 CE (RED) for European Union

According to laws of the member states of the European Union OEM manufacturer or distributor are responsible for the conformity of the product. In order to support our customers we have done a summary for download at the product web site (Attestation of Conformity).

Note the following requirements for CE certification:

The existing R&TTE directive has been replaced by RED (radio equipment directive) since 13<sup>th</sup> of June 2016.

OEM manufacturers or distributors which sell this component as a product to his (final) customers have to fulfill all requirements of the radio equipment directive (RED).

RED contains at least following requirements for OEM manufacturers or distributors:

- Provide product branding (on the product) clearly identifying company name or brand and product name as well as type, charge or serial number for market surveillance
- Include (with the product) documentation containing full postal address of the manufacturer as well as radio frequency band and max. transmitting power
- Include (with the product) user manual, safety information and a declaration of conformity for the final product in local language
- Provide product development and test documentation upon request
- OEM has to fulfill all additional requirements according to RED such as market surveillance or 10 years record retention.

For details and national translations, please see:

<http://eur-lex.europa.eu/legal-content/EN/TXT/?uri=celex:32014L0053>

TCM 515Z – 2.4 GHZ IEEE 802.15.4 Transceiver

## 6.2 FCC (United States) Certificate

**TCB**

**GRANT OF EQUIPMENT  
AUTHORIZATION**

**TCB**

**Certification  
Issued Under the Authority of the  
Federal Communications Commission  
By:**

**EMCCert Dr. Rasek GmbH  
Stoernhofer Berg 15  
91364 Unterleinleiter,  
Germany**

**Date of Grant: 09/04/2017  
Application Dated: 09/04/2017**

**EnOcean GmbH  
Kolpingring 18a  
Oberhaching, 82041  
Germany**

**Attention: Armin Anders , Director Product Marketing**

**NOT TRANSFERABLE**

EQUIPMENT AUTHORIZATION is hereby issued to the named GRANTEE, and is VALID ONLY for the equipment identified hereon for use under the Commission's Rules and Regulations listed below.

**FCC IDENTIFIER:** SZV-TCM515Z  
**Name of Grantee:** EnOcean GmbH  
**Equipment Class:** Digital Transmission System  
**Notes:** 2.4 GHz IEEE 802.15.4 Transceiver  
**Modular Type:** Single Modular

<u>Grant Notes</u>	<u>FCC Rule Parts</u>	<u>Frequency Range (MHZ)</u>	<u>Output Watts</u>	<u>Frequency Tolerance</u>	<u>Emission Designator</u>
	15C	2405,0 - 2480,0	0,002		

Power output listed is peak conducted. The antenna(s) used for this transmitter must be installed to provide a separation distance of at least 20 cm from all persons and must not be co-located or operating in conjunction with any other antenna or transmitter except in accordance with FCC accepted multi-transmitter procedures.



TCM 515Z – 2.4 GHZ IEEE 802.15.4 Transceiver

---

### 6.2.1 FCC (United States) regulatory statement

This device complies with part 15 of the FCC Rules. Operation is subject to the following two conditions:

- (1) this device may not cause harmful interference, and
- (2) this device must accept any interference received, including interference that may cause undesired operation.

### 6.2.2 FCC (United States) labeling requirements

This module is labeled with its own FCC ID number, and, if the FCC ID is not visible when this module is installed inside another device, then the outside of this device into which the module is installed must also display a label referring to this enclosed module.

This exterior label can use wording such as the following:

"Contains Transmitter Module FCC ID: SVZ-TCM515Z"  
 Or alternatively:

"Contains FCC ID: SVZ-TCM515Z"

Any similar wording that expresses the same meaning may be used. Figure 15 below shows an example of such label.

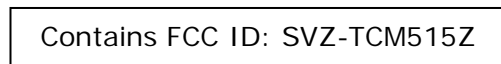

**Figure 15 – Label example**

### 6.2.3 FCC (United States) RF exposure statement

This module must not be used within a separation distance of 20cm or less between the user and/or bystander and the antenna and/or radiating element.

Calculation of e.i.r.p. (effective isotropic radiated power):

conducted output power:	2.9dBm
maximum gain of antenna:	5.0dBi
maximum e.i.r.p.:	7.9dBm
<u>maximum e.i.r.p. in Watts:</u>	<u>0.00617W</u>

Exception limit for conducted output power (or e.i.r.p.), when distance >20cm:	$1.31 \times 10^{-2} f^{0.6834} \text{ W (f in MHz)}$
Frequency:	2500MHz
<u>Limit:</u>	<u>2.75W</u>

TCM 515Z – 2.4 GHZ IEEE 802.15.4 Transceiver

### 6.3 ISED (Industry Canada) Technical Acceptance Certificate



FCB under the Canada-EC MRA  
 TCB under the USA-EC MRA  
 RFCAB under the Japan-EC MRA  
 Notified Body RE Directive 2014/53/EU  
 Notified Body EMC Directive 2014/30/EU

No. CA001779J

#### TECHNICAL ACCEPTANCE CERTIFICATE CANADA

#### CERTIFICAT D'ACCEPTABILITÉ TECHNIQUE CANADA

CERTIFICATION No. ► 5713A-TCM515Z

No. DE CERTIFICATION

ISSUED TO ► EnOcean GmbH

DELIVRE A

Street Address Kolpingring 18 a

Numéro et rue

Province or State Germany

Province ou Etat

City Oberhaching

Ville

Postal Code 82041

Code postal

TYPE OF EQUIPMENT ► Spread Spectrum/Digital Device (2400-2483.5 MHz), Modular Approval

GENRE DE MATERIEL

PMN ► TCM 515Z

HVIN ► TCM 515Z

ANTENNA ► Integrated

ANTENNE

ANTENNA GAIN ► max. 5 dBi

GAIN D'ANTENNE

FVIN ► N/A

FREQUENCY RANGE BANDE DE FRÉQUENCES	EMISSION TYPE GENRE D'ÉMISSION	RF POWER PUISSANCE H.F.	SPECIFICATION / ISSUE / DATE SPÉCIFICATION / ÉDITION / DATE
2405 - 2480 MHz	2M36G1D	0.0059 Watt EIRP	RSS-247 / 2 / February 2017

TEST LABORATORY ► EMCCons DR. RASEK GmbH & Co. KG

LABORATOIRE D'ESSAY

Street Address Stoernhofer Berg 15

Numéro et rue

Province or State Germany

Province ou Etat

Name Patrick Reusch

Nom

E-mail p.reusch@emcc.de

CN 3464C OATS 3464C-1

City Unterleinleiter

Ville

Postal Code 91364

Code Postal

Tel +49 9194 7263-301

Fax +49 9194 7263-309

Certification of equipment means only that the equipment has met the requirements of the above-noted specification. Licence applications, where applicable to use certified equipment, are acted on accordingly by the ISED issuing office and will depend on the existing radio environment, service and location of operation. This certificate is issued on condition that the holder complies and will continue to comply with the requirements and procedures issued by ISED. The equipment for which this certificate is issued shall not be manufactured, imported, distributed, leased, offered for sale or sold unless the equipment complies with the applicable technical specifications and procedures issued by ISED.

La certification du matériel signifie seulement que le matériel a satisfait aux exigences de la norme indiquée ci-dessus. Les demandes de licences nécessaires pour l'utilisation du matériel certifié sont traitées en conséquence par le bureau de délivrance d'ISED et dépendent des conditions radio ambiantes, du service et de l'emplacement d'exploitation. Le présent certificat est délivré à la condition que le titulaire satisfasse et continue de satisfaire aux exigences et aux procédures d'ISED. Le matériel à l'égard duquel le présent certificat est délivré ne doit pas être fabriqué, importé, distribué, loué, mis en vente ou vendu à moins d'être conforme aux procédures et aux spécifications techniques applicables publiées par ISED.

I hereby attest that the subject equipment was tested and found in compliance with the above-noted specification.

J'atteste par la présente que le matériel a fait l'objet d'essai et jugé conforme à la spécification ci-dessus.

DATE 4 September 2017



Certification Officer

## TCM 515Z – 2.4 GHZ IEEE 802.15.4 Transceiver

### 6.3.1 ISED (Industry Canada) regulatory statement

This device complies with Industry Canada licence-exempt RSS standard(s).  
 Operation is subject to the following two conditions:

- (1) this device may not cause interference, and
- (2) this device must accept any interference, including interference that may cause undesired operation of the device.

Le présent appareil est conforme aux CNR d'Industrie Canada applicables aux appareils radio exempts de licence.

L'exploitation est autorisée aux deux conditions suivantes :

- (1) l'appareil ne doit pas produire de brouillage, et
- (2) l'utilisateur de l'appareil doit accepter tout brouillage radioélectrique subi, même si le brouillage est susceptible d'en compromettre le fonctionnement."

### 6.3.2 IC (Industry Canada) RF exposure statement

This module must not be used within a separation distance of 20cm or less between the user and/or bystander and the antenna and/or radiating element.

Calculation of e.i.r.p. (effective isotropic radiated power):

conducted output power:	2.9dBm
maximum gain of antenna:	5.0dBi
maximum e.i.r.p.:	7.9dBm
<u>maximum e.i.r.p. in Watts:</u>	<u>0.00617W</u>

Exception limit for conducted output power (or e.i.r.p.), when distance >20cm:	$1.31 \times 10^{-2} f^{0.6834} \text{ W}$
Frequency:	2500MHz
<u>Limit:</u>	<u>2.75W</u>

## Appendix A IEEE 802.15.4 Frame Structure

### A.1 IEEE 802.15.4 High Level Frame Structure

TCM 515Z transmits and receives radio telegrams in the 2.4 GHz band according to IEEE 802.15.4 frame structure. The external host is responsible for the proper decoding of received telegrams and proper encoding of telegrams to be transmitted.

The following information about the IEEE 802.15.4 standard and its implementation in PTM 215ZE and PTM 515Z is given for reference only. Please refer to the applicable documents for detailed information.

Note that the data format is little endian. This means that for multi-byte structures (such as 2 byte, 4 byte or 8 byte fields) the least significant byte (LSB) is transmitted first.

The IEEE 802.15.4 frame structure consists of the following four main parts:

- **PHY Header**  
The PHY header indicates to the receiver the start of a transmission and provides information about the length of the transmission.  
It contains the following fields:
  - Preamble  
Pre-defined sequence (4 byte, value 0x00000000) used to adjust the receiver to the transmission of the sender
  - Start of frame  
Pre-defined symbol (1 byte, value 0xA7) identifying the start of the actual data frame
  - Length of Frame  
1 byte indicating the combined length of all following fields
- **MAC Header**  
The MAC header provides detailed information about the frame.  
It contains the following fields:
  - Frame control field  
2 bytes to identify frame type, protocol version, addressing and security mode
  - Sequence number  
1 byte sequential number to identify the order of transmitted frames
  - Address  
PAN ID and address of source (if present) and destination of the telegram  
EnOcean PTM 535Z and PTM 215ZE do not use source address and source PAN ID (the EnOcean ID is part of the payload).
- **MAC Payload**  
The MAC Payload field contains telegram control, device ID, telegram data and telegram security (if present) fields.  
The MAC Payload field structure depends on telegram type (data or commissioning) and security mode (secure or standard transmission).

TCM 515Z – 2.4 GHZ IEEE 802.15.4 Transceiver

- **MAC Trailer**  
The MAC Trailer contains the Frame Check Sum (FCS) field used to verify the integrity of the telegram data.

Figure 16 below summarizes the IEEE 802.15.4 frame structure.

PHY Header			MAC Header			MAC Payload	MAC Trailer
Preamble	Start of Frame	Length of Frame	Frame Control	Sequence Number	DstAddress PAN   Addr	Depending on Telegram Type	Frame Check Sum
4 Byte	1 Byte	1 Byte	2 Byte	1 Byte	4 Byte	Depending on Telegram Type	2 Byte

**Figure 16: IEEE 802.15.4 frame structure**

The content of these fields is described in more detail below.

## A.2 PHY Header

The IEEE 802.15.4 PHY header consists of the following fields:

- Preamble
- Start of Frame
- Length of Frame fields

The content of the Preamble and Start of Frame fields is fixed for all telegram types supported by EnOcean devices as follows:

- Preamble = 0x00000000
- Start of Frame = 0xA7

### A.2.1 Length of Frame values used by PTM 215ZE and PTM 535Z

Below are reference values for the *Length of Frame* field for different type of telegrams used by PTM 215ZE and PTM 535Z:

- Secure commissioning telegram (Default for PTM 215ZE and PTM 535Z)  
*Length of Frame* = 42 bytes (0x2A)
- Secure data telegram (Default for PTM 215ZE and PTM 535Z)  
*Length of Frame* = 24 bytes (0x18)
- Standard commissioning telegram (Optional feature for PTM 535Z only)  
*Length of Frame* = 17 bytes (0x11)
- PTM switch: Standard data telegram (Optional feature for PTM 535Z only)  
*Length of Frame* = 15 bytes (0x0F)

## TCM 515Z – 2.4 GHZ IEEE 802.15.4 Transceiver

---

### A.3 MAC Header

The IEEE 802.15.4 MAC Header contains the following fields:

- **Frame Control Field (2 byte)**  
The Frame Control Field is set to 0x0801 in PTM 215ZE and PTM 535Z telegrams in order to identify them as data telegrams with short addresses based on version IEEE 802.15.4-2003
- **Sequence Number (1 byte)**  
The Sequence Number is an incremental number used to identify the order of telegrams
- **Address Field (4 byte in EnOcean implementation)**  
EnOcean devices use short Destination Address (16 Bit) together with the Destination PAN ID (16 Bit). Both are set to 0xFFFF to identify the telegrams as broadcast. Source address and Source PAN ID are not used by PTM 215ZE and PTM 535Z.

### A.4 MAC Payload

The IEEE 802.15.4 MAC Payload depends on the telegram type. Appendix B describes the MAC Payload structure used by EnOcean PTM 215ZE and PTM 535Z products.

### A.5 MAC Trailer

The MAC Trailer only contains the Frame Check Sum (FCS) field.

Its length is 2 byte and it is calculated as Cyclic Redundancy Check (CRC16) over the entire MAC payload including the Length field of the PHY Header using the following polynomial:  
 $x^{16} + x^{12} + x^5 + 1$

TCM 515Z will automatically calculate and append the frame check sum to radio telegrams it is transmitting.

For received radio telegrams, TCM 515Z will calculate the frame check sum and verify data integrity based on that. If the checksum does not match, the received radio telegram will be discarded. Otherwise the received radio telegram will be forwarded to the external host via the ESP3 interface.



## Appendix B MAC Payload Structure

The MAC Payload depends on the telegram type. This appendix gives examples of MAC payload structures used by EnOcean PTM 215ZE and PTM 535Z devices.

The following telegram types are used by these devices:

- Data telegram
- Commissioning telegram

The following security modes are supported by these devices:

- Secure (authenticated) communication (using AES128 authentication)  
Default mode on PTM 215ZE and PTM 535Z
- Standard communication (without AES128 authentication)  
Optional mode for PTM 535Z, not available for PTM 215ZE

Standard communication (without AES128 security processing) is supported as an optional feature for PTM 535Z in case shorter payloads are desired for certain applications without requirements for telegram authentication. This mode is not available for PTM 215ZE.

## TCM 515Z – 2.4 GHZ IEEE 802.15.4 Transceiver

## B.1 Secure data telegram format (with authentication)

Figure 17 below shows the MAC Payload structure of a secure data telegram with authentication used by PTM 215ZE or PTM 535Z.

Telegram Control	Source ID	Sequence Counter	Command	Telegram Signature
2 Byte	4 Byte	4 Byte	1 Byte	4 Byte

**Figure 17: MAC Payload structure for authenticated data telegrams**

The following fields are used:

- **Telegram Control (2 bytes)**  
 The default security mode of PTM 215ZE and PTM 535Z uses a 4 byte payload signature based on a device-unique key and a 4 byte Sequence Counter. The *Telegram Control* field is set to 0x308C for this mode.
- **Source ID (4 bytes)**  
 The *Source ID* field contains a 4 byte ID uniquely identifying each PTM 215ZE or PTM 535Z device
- **Sequence Counter (4 bytes)**  
 The *Sequence Counter* field contains an always incrementing counter. Security processing is based on the combination of the Command and Sequence Counter in order to prevent replay attacks (sending the same telegram again)
- **Command (1 byte)**  
 The *Command* field is a one byte field which identifies the state of the different inputs of PTM 215ZE or PTM 535Z. For the encoding please see the applicable data manual.
- **Telegram Signature (4 byte)**  
 The *Telegram Signature* field is used to validate the telegram authenticity. The telegram signature is calculated based on the telegram payload using AES128 (CBC mode).

In this mode, telegrams contain both a 4 byte sequence counter and a 4 byte signature which is calculated based on the telegrams payload (including the sequence counter) and the private key. The implementation is specified in RFC3610 and compatible with ZigBee systems.

EnOcean can provide upon request additional information on how to implement telegram validation for PTM 215ZE or PTM 535Z data telegrams.

## B.2 Secure commissioning telegram format (with authentication)

Figure 18 below shows the MAC payload structure of a secure commissioning telegram used by PTM 215ZE and PTM 535Z.

Telegram Control	Source ID	Commissioning Command	Device Type	Device Options	Device-unique Security Key	Security Key Validation	Sequence Counter
1 Byte	4 Byte	1 Byte	1 Byte	2 Byte	16 Byte	4 Byte	4 Byte

**Figure 18: MAC Payload structure for secure commissioning telegrams**

The following fields are used for secure commissioning telegrams:

- **Telegram Control (1 byte)**  
 The *Telegram Control* field is set to 0x0C to identify a standard telegram (secure communication will be established based on the commissioning telegram)
- **Source ID (4 bytes)**  
 The *Source ID* field contains a 4 byte ID uniquely identifying each PTM 215ZE or PTM 535ZE device
- **Commissioning Command (1 byte)**  
 The *Command* field is set to 0xE0 by PTM 215ZE and PTM 535Z
- **Device Type (1 byte)**  
 The *Device Type* field is set to 0x02 by PTM 215ZE and PTM 535Z
- **Device Options (2 bytes)**  
 The *Device Options* field is set to 0xF281 by PTM 215ZE and PTM 535Z when operating in AES128 secure mode with authentication.  
 The *Device Options* field is set to 0xF381 by PTM 535Z when operating in AES128 secure mode with authentication and additional payload encryption (optional feature).
- **Device-unique Security Key (16 bytes)**  
 PTM 215ZE and PTM 535Z implement a random, device-specific security key which is generated as part of the production flow. During commissioning, this key is transmitted in encrypted format. Contact EnOcean for details.
- **Security Key Validation (4 bytes)**  
 In order to ensure correct reception, an additional 4 byte validation value is provided. Contact EnOcean for details.
- **Sequence Counter (4 bytes)**  
 The *Sequence Counter* is an always incrementing counter which is used as part of the security processing to avoid replay attacks (sending the same telegram again).
- Receiving devices shall only accept data telegrams with sequence counter values higher than that of the last received telegram; therefore the current value needs to be communicated during commissioning.

### B.3 Standard data telegram format (without authentication)

Figure 19 below shows the MAC Payload structure of a standard data telegram. This telegram type is an optional feature of PTM 535Z.

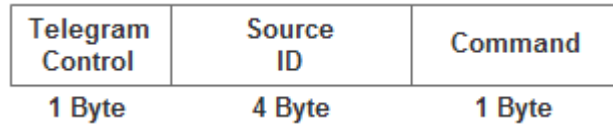

**Figure 19: MAC Payload structure for standard data telegrams**

The following fields are used for Standard Data Telegrams:

- Telegram Control (1 byte)  
The *Telegram Control* field is set to 0x0C by PTM 535Z to identify a standard data telegram
- Source ID (4 bytes)  
The *Source ID* field contains a 4 byte ID uniquely identifying each PTM 535Z device
- Command (1 byte)  
The *Command* field is a one byte field which identifies the state of the PTM 215ZE button contacts or PTM 535Z input signals. For the encoding please refer to the applicable datasheet.

#### B.4 Standard commissioning telegram (without authentication)

Figure 20 below shows the MAC payload structure of a standard commissioning telegram used by PTM 535Z.

Telegram Control	Source ID	Commissioning Command	Device Type	Device Options
1 Byte	4 Byte	1 Byte	1 Byte	1 Byte

**Figure 20: MAC Payload structure for standard commissioning telegrams**

The following fields are used for standard commissioning telegrams:

- Telegram Control (1 byte)  
The *Telegram Control* field is set to 0x0C to identify a standard telegram (secure communication will be established based on the commissioning telegram)
- Source ID (4 bytes)  
The *Source ID* field contains a 4 byte ID uniquely identifying each PTM 535Z device
- Commissioning Command (1 byte)  
The *Commissioning Command* field is set to 0xE0 by PTM 535Z
- Device Type (1 byte)  
The *Device Type* field is set to 0x02 by PTM 535Z
- Device Options (1 byte)  
The *Device Options* field is set to 0x01 by PTM 535Z

## Appendix C ESP3 Interface Format

### C.1 Packet Type 0x10: IEEE 802.15.4 Raw Packet

In receive mode, TCM 515Z forwards the content of received IEEE 802.15.4 radio telegrams (which pass frame check sum validation) unmodified to the external host via the ESP3 interface.

The forwarded frame starts with the *Length* field of the IEEE 802.15.4 PHY Header, continues with the MAC Header and ends with the last Byte of the MAC Payload. The frame check sum (MAC Trailer) will not be forwarded to the host.

In transmit mode, TCM 515Z receives from the external host the precomputed message payload starting with the *Length* field of the IEEE 802.15.4 PHY Header, continuing with the MAC Header and ending with the last Byte of the MAC Payload.

TCM 515Z then calculates the frame check sum (MAC Trailer) based on the received payload and appends it to the message. The full frame (including the Preamble and Start of Frame fields) will then be transmitted as IEEE 802.15.4 radio telegram (TX mode).

#### C.1.1 ESP3 packet structure for IEEE 802.15.4 Raw Packets

The MAC frame is embedded as 802.15.4 payload into the ESP3 packet as shown in Figure 21 below.

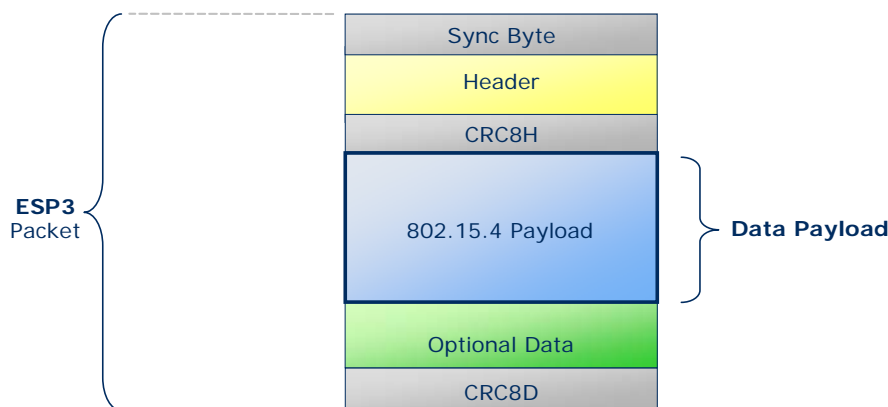

Figure 21: ESP3 packet structure for IEEE 802.15.4 Raw Packets

TCM 515Z – 2.4 GHZ IEEE 802.15.4 Transceiver

The detailed structure of the IEEE 802.15.4 Raw Packets is shown in Table 7 below. IEEE 802.15.4 Raw Packets are identified by Packet Type 0x10.

Group	Offset	Size	Field	Value hex	Description
-	0	1	Sync. byte	0x55	
Header	1	2	Data Length	0xn timer	Variable length x of raw packet payload
	3	1	Optional Length	0x01	1 field fixed
	4	1	Packet Type	0x10	Packet Type 0x10: 802.15.4 Raw Packet
-	5	1	CRC8H	0xnn	
Data	6	x	Raw data	...	802.15.4 Raw Packet payload
Optional Data	6+x	1	RSSI	0xnn	Send case: FF Receive case: best RSSI value of all received sub telegrams (value decimal without minus)
-	7+x	1	CRC8D	0xnn	CRC8 Data byte; Calculated checksum for whole byte groups: DATA and OPTIONAL_DATA

**Table 7 – Packet structure for IEEE 802.15.4 Raw Packets**

### C.1.2 RESPONSE for IEEE 802.15.4 Raw Packets

When receiving a telegram, no RESPONSE has to be sent from the external host to the gateway to acknowledge reception of the telegram via ESP3 interface.

When transmitting a telegram, the gateway will send a RESPOND message to the external host via ESP3 interface to indicate the acceptance of the telegram for transmission. The following return codes are applicable for such a RESPONSE message:

- 00 RET\_OK
- 02 RET\_NOT\_SUPPORTED
- 03 RET\_WRONG\_PARAM

The structure of the gateway RESPONSE message to the request for transmission of an IEEE 802.15.4 Raw Packet is shown in Table 8 below. TCM 515Z will transmit a dedicated message to a connected host if transmission of an accepted telegram subsequently fails.

Group	Offset	Size	Field	Value hex	Description
-	0	1	Sync. byte	0x55	
Header	1	2	Data Length	0x0004	1 byte
	3	1	Optional Length	0x00	0 byte
	4	1	Packet Type	0x02	Packet Type 0x02: RESPONSE
-	5	1	CRC8H	0xnn	
Data	6	1	Return Code	0xnn	00 / 02 / 03
-	7	1	CRC8D	0xnn	

**Table 8 - RESPONSE frame structure to IEEE 802.15.4 Raw Packet transmission**

### C.1.3 Failure Indication for IEEE 802.15.4 Raw Packet

TCM 515Z will accept and immediately acknowledge via ESP3 correctly formatted telegrams for radio transmission as described above.

Should transmission subsequently fail due to channel non-availability then this will be subsequently indicated to the host using an ESP3 Event (Packet Type 0x04) with Event Code 07: CO\_TRANSMIT\_FAILED.

The structure of ESP3 Event messages is shown in Figure 22 below.

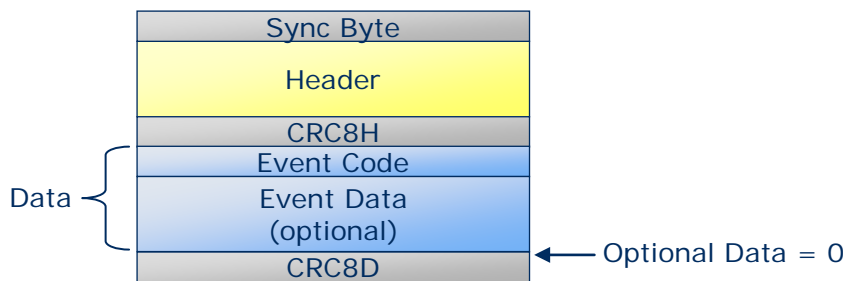

**Figure 22: ESP3 packet structure for Events**

The structure of the CO\_TRANSMIT\_FAILED Event is shown in Table 9 below.

Group	Offset	Size	Field	Value hex	Description
-	0	1	Sync. Byte	0x55	
Header	1	2	Data Length	0x0002	2 bytes
	3	1	Optional Length	0x00	0 byte
	4	1	Packet Type	0x04	EVENT = 4
-	5	1	CRC8H	0xnn	
Data	6	1	Event Code	0x07	CO_TRANSMIT_FAILED = 7
	7	1	Event Cause	0xnn	00 = CSMA failed, channel was never free 01 = No Acknowledge received, telegram was transmitted, but no ack received. 02...255 = reserved
-	8	1	CRC8D	0xnn	

**Table 9 – Structure of Event Code 07: CO\_TRANSMIT\_FAILED**



## C.2 Packet Type 0x11: IEEE 802.15.4 COMMAND

The packet type IEEE 802.15.4 COMMAND is used to set and read parameters of TCM 515Z.

### C.2.1 Packet structure for IEEE 802.15.4 COMMAND

The packet structure for IEEE 802.15.4 COMMAND is shown in Figure 23 below.

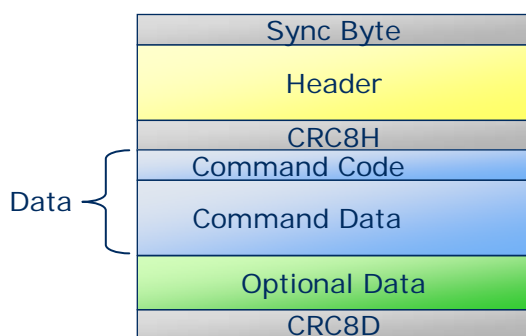

**Figure 23 - Packet structure for IEEE 802.15.4 COMMAND**

The structure of supported commands and expected responses are described in detail in the following chapters.

### C.2.2 List of supported commands

Table 10 below lists the currently supported commands.

Code	Command Name	Description
01	SET_CHANNEL	Sets the radio channel used by the gateway
02	GET_CHANNEL	Reads the radio channel used by the gateway

**Table 10 - List of supported commands**

TCM 515Z – 2.4 GHZ IEEE 802.15.4 Transceiver

### C.2.3 SET\_CHANNEL Command

The SET\_CHANNEL command sets the radio channel used by TCM 515Z. Please refer to chapter 2.3 for details about the supported radio channels.

The command structure of the SET\_CHANNEL command is shown in Table 11 below.

Group	Offset	Size	Field	Value hex	Description
-	0	1	Sync. byte	0x55	
Header	1	2	Data Length	0x0002	2 bytes
	3	1	Optional Length	0x00	0 byte
	4	1	Packet Type	0x11	Packet Type 0x11: IEEE 802.15.4 COMMAND
-	5	1	CRC8H	0xnn	
Data	6	1	COMMAND Code	0x01	COMMAND 0x01: SET_CHANNEL
	7	1	Channel	11-26	IEEE 802.15.4 radio channel
-	8	1	CRC8D	0xnn	

**Table 11 - Command Structure for the SET\_CHANNEL command**

### C.2.4 RESPONSE for SET\_CHANNEL Command

The expected RESPONSE code for a SET\_CHANNEL command is:

- 00: RET\_OK

The frame structure for a RESPONSE to the SET\_CHANNEL command is shown in Table 12 below.

Group	Offset	Size	Field	Value hex	Description
-	0	1	Sync. byte	0x55	
Header	1	2	Data Length	0x0001	1 byte
	3	1	Optional Length	0x00	0 byte
	4	1	Packet Type	0x02	Packet Type 0x02: RESPONSE
-	5	1	CRC8H	0xnn	
Data	6	1	Return Code	0xnn	00
-	7	1	CRC8D	0xnn	

**Table 12 - RESPONSE Frame Structure for SET\_CHANNEL command**

### C.2.5 GET\_CHANNEL Command

The GET\_CHANNEL command requests information about the radio channel currently used by TCM 515Z. The command structure of the GET\_CHANNEL command is shown in Table 13 below.

Group	Offset	Size	Field	Value hex	Description
-	0	1	Sync. byte	0x55	
Header	1	2	Data Length	0x0001	1 byte
	3	1	Optional Length	0x00	0 byte
	4	1	Packet Type	0x11	Packet Type 0x11: IEEE 802.15.4 COMMAND
-	5	1	CRC8H	0xnn	
Data	6	1	COMMAND Code	0x02	COMMAND 0x02: GET_CHANNEL
-	7	1	CRC8D	0xnn	

**Table 13 - Command structure of the GET\_CHANNEL command**

### C.2.6 RESPONSE for GET\_CHANNEL Command

The expected RESPONSE code for a GET\_CHANNEL command issued to TCM 515Z is:

- 00: RET\_OK

The currently used radio channel is then encoded in the subsequent byte. The frame structure for a RESPONSE to the GET\_CHANNEL command is shown in Table 14 below.

Group	Offset	Size	Field	Value hex	Description
-	0	1	Sync. byte	0x55	
Header	1	2	Data Length	0x0002	2 bytes
	3	1	Optional Length	0x00	0 byte
	4	1	Packet Type	0x02	COMMAND 0x02: GET_CHANNEL
-	5	1	CRC8H	0xnn	
Data	6	1	Return Code	0	OK
	7	1	Channel	11..26	Used Channel
-	8	1	CRC8D	0xnn	

**Table 14 - RESPONSE frame structure for GET\_CHANNEL command**

### C.3 Packet Type Common Command

#### C.3.1 Command Code 0x24: CO\_SET\_BAUDRATE

The command CO\_SET\_BAUDRATE modifies the baud rate of the ESP3 interface. The standard baud rate defined by the ESP3 interface is 57600 Baud. TCM 515Z supports faster baud rates as listed in Table 15 below.

Group	Offset	Size	Field	Value hex	Description
-	0	1	Sync. byte	0x55	
Header	1	2	Data Length	0x0002	2 bytes
	3	1	Optional Length	0x00	0 byte
	4	1	Packet Type	0x05	COMMON_COMMAND = 0x05
-	5	1	CRC8H	0xnn	
Data	6	1	COMMAND Code	0x24	CO_SET_BAUDRATE = 0x24
	7	1	BAUDRATE	0xnn	0x00 = 57600 BAUD 0x01 = 115200 BAUD 0x02 = 230400 BAUD 0x03 = 460800 BAUD
-	8	1	CRC8D	0xnn	

**Table 15 - Command structure of the CO\_SET\_BAUDRATE command**

**Caution:** Before using the CO\_SET\_BAUDRATE command, make sure that the host connected via the ESP3 interface supports the intended baud rate!

#### C.3.2 RESPONSE for CO\_SET\_BAUDRATE Command

Possible RESPONSE codes to a CO\_SET\_CHANNEL command are:

- 00: RET\_OK
- 02: RET\_NOT\_SUPPORTED

The frame structure for a RESPONSE to the CO\_SET\_CHANNEL command is shown in Table 16 below.

Group	Offset	Size	Field	Value hex	Description
-	0	1	Sync. byte	0x55	
Header	1	2	Data Length	0x0001	Data = 1 byte
	3	1	Optional Length	0x00	Optional Data = 0 byte
	4	1	Packet Type	0x02	RESPONSE = 2
-	5	1	CRC8H	0xnn	
Data	6	1	Return Code	0x00	RET_OK
-	7	1	CRC8D	0xnn	

**Table 16 - RESPONSE frame structure for CO\_SET\_BAUDRATE command**

### C.3.3 Command Code 0x25: CO\_GET\_FREQUENCY\_INFO

The command CO\_GET\_FREQUENCY\_INFO reports the radio frequency and the communication protocol used by the device. The structure of the command is listed in Table 17 below.

Group	Offset	Size	Field	Value hex	Description
-	0	1	Sync. Byte	0x55	
Header	1	2	Data Length	0x0001	1 bytes
	3	1	Optional Length	0x00	0 byte
	4	1	Packet Type	0x05	COMMON_COMMAND = 5
-	5	1	CRC8H	0xnn	
Data	6	1	COMMAND Code	0x25	CO_GET_FREQUENCY_INFO = 37
-	7	1	CRC8D	0xnn	

**Table 17 - Command structure of the CO\_GET\_FREQUENCY\_INFO command**

### C.3.4 RESPONSE for CO\_GET\_FREQUENCY\_INFO Command

Possible RESPONSE codes to a CO\_GET\_FREQUENCY\_INFO command are:

- 00: RET\_OK
- 02: RET\_NOT\_SUPPORTED

The frame structure for a RESPONSE to the CO\_SET\_CHANNEL command on devices that support this command is shown in Table 18 below.

Group	Offset	Size	Field	Value hex	Description
-	0	1	Sync. Byte	0x55	
Header	1	2	Data Length	0x0003	3 bytes
	3	1	Optional Length	0x00	0 byte
	4	1	Packet Type	0x02	RESPONSE = 2
-	5	1	CRC8H	0xnn	
Data	6	1	Return Code	0x00	RET_OK = 0
	7	1	Frequency	0xnn	0x00 315Mhz 0x01 868.3Mhz 0x02 902.875Mhz 0x03 925 Mhz 0x04 928 Mhz 0x20 2.4 Ghz
Data	8	1	Protocol	0xnn	0x00 ERP1 0x01 ERP2  0x10 802.15.4 0x20 Bluetooth 0x30 Long Range
	-	9	1	CRC8D	0xnn

**Table 18 - RESPONSE frame structure for CO\_GET\_FREQUENCY\_INFO command**

### C.3.5 Command Code 37: CO\_GET\_STEP CODE

The command CO\_GET\_STEP CODE reports the device revision. The Stepcode is expressed as combination as major revision (DA, DB, DC, ...) and minor revision (01, 02, 03, ...). The structure of the command is listed in Table 19 below.

Group	Offset	Size	Field	Value hex	Description
-	0	1	Sync. Byte	0x55	
Header	1	2	Data Length	0x0001	1 bytes
	3	1	Optional Length	0x00	0 byte
	4	1	Packet Type	0x05	COMMON_COMMAND = 5
-	5	1	CRC8H	0xnn	
Data	6	1	COMMAND Code	0x27	CO_GET_STEP CODE = 39
-	7	1	CRC8D	0xnn	

Table 19 - Command structure of the CO\_GET\_STEP CODE command

### C.3.6 RESPONSE for CO\_GET\_STEP CODE Command

Possible RESPONSE codes to a CO\_GET\_STEP CODE command are:

- 00: RET\_OK
- 02: RET\_NOT\_SUPPORTED

The frame structure for a RESPONSE to the CO\_GET\_STEP CODE command on devices that support this command is shown in Table 20 below.

Group	Offset	Size	Field	Value hex	Description
-	0	1	Sync. Byte	0x55	
Header	1	2	Data Length	0x00023	3 bytes
	3	1	Optional Length	0x00	0 byte
	4	1	Packet Type	0x02	RESPONSE = 2
-	5	1	CRC8H	0xnn	
Data	6	1	Return Code	0x00	RET_OK = 0
	7	1	Major Revision	0xnn	e.g. 0xDA, 0xDB ...
	8	1	Minor Revision	0xnn	e.g. 0x01, 0x02 ...
-	9	1	CRC8D	0xnn	

Table 20 - RESPONSE frame structure for CO\_GET\_STEP CODE command