

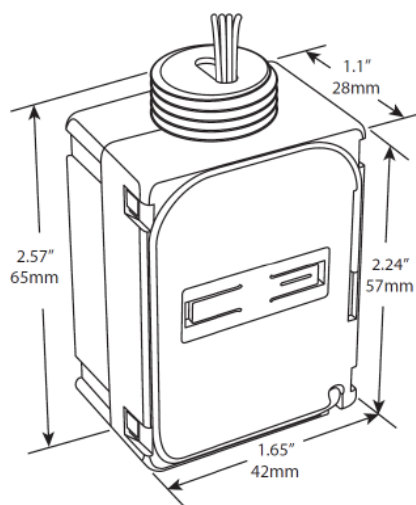

HVAC Setback Module



Package Contents

- HVAC Setback Module
- Double-sided adhesive pad

Tools Required

- Owner's manual for the HVAC model
- Wiring connectors, type varies per HVAC model

Product Description

The HVAC Setback Module is a simple way to save energy by switching HVAC units between normal and setback modes.

It is low voltage, mounts easily in a typical HVAC enclosure, and communicates wirelessly with EnOcean wireless occupancy detection and lighting control products.

Features Include:

- Switches HVAC to setback mode to save energy
- Powered by HVAC via standard 24 VAC connection
- Receives wireless messages from EnOcean-based devices to determine room occupancy
- Controls setback range by built-in temperature sensor
- Provides simple input signal by dry contact to compatible HVAC systems
- Concealed easily within HVAC enclosure
- Sends wireless messages to other controlled devices; configurable transceiver

Specifications

Power Supply	9-30 VAC, 12-40 VDC
Maximum Load	1A @ 24 VAC/VDC
Temperature Sensing Range	Temperature Sensing Range 32° to 104° F (0° to 40° C)
Temperature Sensor Accuracy	± 1.8° F @ 50° to 90° F (± 1° C @ 10° to 32° C)

RF Communications	EnOcean 902 MHz (EHSMU) EnOcean 315 MHz (EHSMC)
Interoperable Products / EEPs (EnOcean Equipment Profiles)	[Product Name (EEP #)] Rocker Pad Switch (F6-02-02) Key Card Switch (F6-04-01) 1BS Single Input Contact (D5-00-01) Temperature Sensor, 0 - 40° C (A5-02-05) Occupancy Sensor (A5-07-01) Occupancy Sensor (A5-07-02) Occupancy Sensor (A5-07-03) Contact, single input (A5-30-02)
Dimensions	2.57" H x 1.65" W x 1.10" D (6.5 cm x 4.2 cm x 2.8 cm)
Weight	1.9 oz. (54 g)
Mounting	<ul style="list-style-type: none"> • Install inside standard electrical box • Connect to electrical boxes and fixtures using threaded nipple
Environment	<ul style="list-style-type: none"> • Indoor use only • 32° to 104°F (0° to 44°C) • 20% to 95% relative humidity (non-condensing)
Agency Compliance	ETL, FCC, IC

1. Planning

Take a moment to plan for the module's successful operation and optimal communication with other system components.

- Always use a qualified installer
- Review HVAC unit's manual to assess control compatibility
- Identify the high voltage wiring and how to disconnect it locally and at the circuit breaker panel
- Identify a location in the HVAC enclosure that is free from housing obstructions and as far away as possible from the HVAC unit's control panel to avoid signal interference
- Make sure the wires are straight (avoid loops and coils)
- Take care not to damage the radio antenna that runs in a groove on the front side of the module
- Consider the construction materials in the space and obstacles that may interfere with RF signals

2. Installing

estimated time: 20 minutes



Read and understand instructions completely before starting.

	<p>ELECTRICAL SHOCK HAZARD</p> <p>High Voltage. This device must be installed by a qualified installer or electrician. Follow all applicable electrical codes for installation.</p>
--	--

1. Turn off power at the circuit breaker or unplug the HVAC unit and test that power is off.
2. Consult the HVAC unit's manual to:
 - A. Safely remove the enclosure and any obstructions that prevent access to the wiring.
 - B. Confirm the HVAC unit has the required control input, typically called, front desk or energy management.
 - C. Identify low voltage output to power the module.
 - D. Identify the type and the number of control terminals. Each HVAC brand uses their own terminal codes, e.g.: FD1, FD2, CDC1, CDC2, or EMS1, EMS2.
 - E. Identify the appropriate electrical connectors: terminal screws or pins, butt splice connectors, wire nuts.
3. Connect the module's Red and Black wires to the low voltage power output from the HVAC unit.
4. Connect the module's Yellow wires to the appropriate control terminals of the HVAC unit.

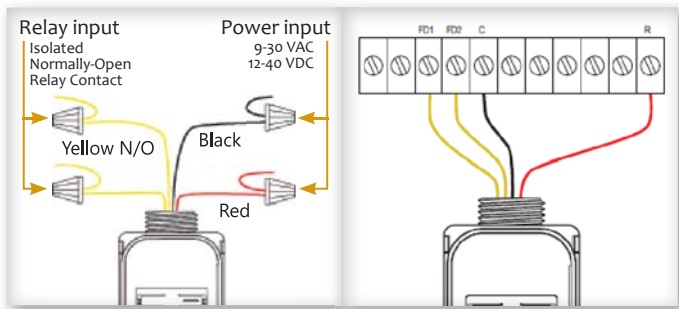
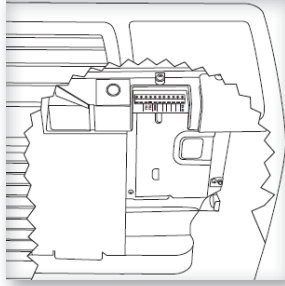

5. Apply double-sided adhesive pad to the back of the module.

TIP: To avoid distorting the temperature sensor, do not install the module in the path of blowing air.

NOTE: It may be easier to link and configure devices before mounting the module, see the Linking and Configuring sections.
6. Attach the module to the inside wall of the HVAC enclosure and position it so you can access the setup interface (buttons/LEDs).

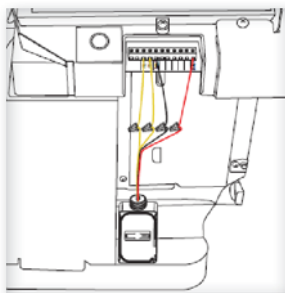

TIP: To limit the potential risk of signal interference, position the module within the enclosure as far away as possible from the unit's control panel.

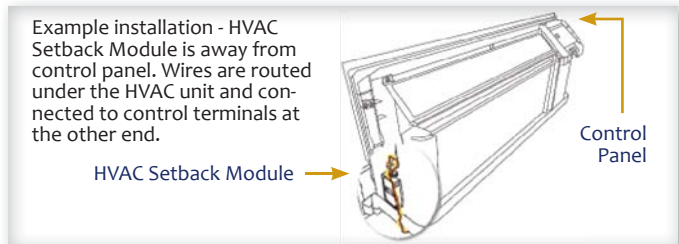

7. Restore power to the circuit.

The LEDs on the module will blink and then the right LED will display solid red when the relay is open, or green when the relay is closed (setback engaged).

3. Linking

Two or more compatible devices can be linked and configured to provide the desired control. There are two basic types of devices in the system; transmitters and transceivers.

- **Transmit-only:** Transmitters are simple energy-harvesting devices that send RF messages to communicate a condition, level, or state. Transmitters can only be linked to transceivers. Examples > Self-powered Light Switches, Occupancy Sensors
- **Transmit & Receive:** Transceivers are controlling devices that send as well as receive RF messages. They also process relevant control logic, and actuate the appropriate outputs (switching a light on or off for example). Transceivers can be linked with transmitters as well as other transceivers. A transceiver can have up to 30 devices linked to it. Examples > Relays, Gateways

The HVAC Setback Module is a Transceiver (transmits & receives)

To link the occupancy sensor to a transceiver; the transceiver must first be powered, within wireless range of the controls it is to be linked to, and set to accept links.

Next, the desired transmitter, or another transceiver, is triggered to send a special link message. The awaiting transceiver receives and stores the link permanently so the devices can interact to provide a variety of intelligent control options.

About the Setup Interface

The setup interface has two buttons, Menu and Set, that each have a corresponding 3-color LED (green, amber, red). This simple interface is used to link and configure devices as a system.

The buttons and LEDs are used to navigate and select linking and setup options through a 3-tier menu system consisting of different Modes > Menus > Options.

To use the interface, hold the module so both thumbs can click the buttons without obscuring the LEDs. The illustration and legend below describe how the buttons are used and the meaning of the LED responses.

To exit from anywhere in a menu, hold both buttons at the same time for 2 seconds.

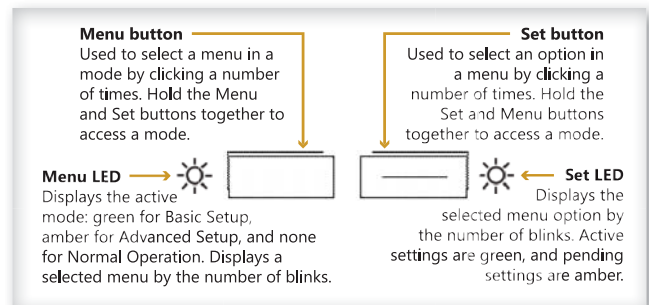

	The Menu LED or Set LED display solid for a number of seconds in a certain color to indicate a mode or a confirmation.
	The Menu LED blinks a number of times in a color to indicate a selected menu.
	The Set LED blinks a number of times in a color to indicate an option.
	A number in a white box indicates the number of times to click the Menu button or Set button.
	A number in a black box indicates the number of seconds to hold down the Menu button or Set button.

To link a transmitter to a transceiver

1. Access Basic Setup mode.

NOTE: By default, the Accept Link option in the Linking menu is selected. Once activated, this option stays active for two minutes to provide time to link multiple devices.

Ready to accept links.

2. For the transmitter to be linked, do one of the following according to the type of device:
 - A. Sensor: click the designated link button.
 - B. Key Card Switch: insert/remove the card 3 times quickly.
 - C. Rocker Pad: click the top button 3 times quickly.

Device linked successfully.
Set LED displays solid green for 3 seconds.

Ready to accept new links.

- D. To exit mode and return to normal operation, press and hold both buttons for 2 seconds.

To unlink a device

Follow the same steps as described in the "To link..." section above with the following deviations:

- After step 1 in the "To link..." section above, click the "Set" (right) button 3 times to enable the "Remove Link" option.

Ready to remove links.

- Follow the same instructions as shown in Step 2 of the "To link..." section. The Set (right) LED will turn red briefly to indicate the link was successfully removed.

To restore factory defaults

Follow these steps to clear all linked devices and restore the HVAC Setback Module to its factory default settings.

1. Press and hold both buttons for 15 seconds
>> Hold buttons until the Menu (left) LED is solid RED and the Set (right) LED is solid Amber (Both LEDs will turn various colors as the module cycles through the resetting process.
2. Press and hold the Set (right) button for 3 seconds to confirm factory reset.
3. Device will reboot and initiate start up LED sequence.

4. Configuring

The default settings on the module support common control and installation scenarios. However, some setback and occupancy settings can be adjusted on the module using the setup interface, if required.

Setting	Default	Application
Heat Setback	40°F (5°C)	If setback range is managed by the HVAC unit.
Cool Setback	Disabled	If setback range is managed by the HVAC unit.
Vacancy Check	5 minutes	If linked to a occupancy sensor and a door sensor.
Door/Window Ajar	2 minutes	If linked to an occupancy sensor.
Egress	30 seconds	If linked to a key card switch.

Temperature Setback Points

The heating and cooling setback points determine a temperature range where the HVAC system will remain inactive when setback is engaged.

If the ambient temperature exceeds the setback range, the HVAC system will override the setback to avoid temperature extremes. By default, the setback range is managed by the HVAC system. However, the HVAC Setback Module includes a built-in temperature sensor which can be used to control the setback range when applicable.

Heat Options	Clicks	Blinks
Disabled		
66°F (19°C)		
62°F (17°C)		
58°F (14°C)		
40°F (5°C) (default)		

From the Heat and Cool Setback menus, the active option is indicated by the number of green blinks on the Set LED; amber blinks indicate an unsaved change. Click the Set button an appropriate number of times to select an option.

















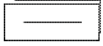



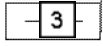



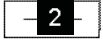

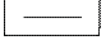

Cool Options	Clicks	Blinks
Disabled (default)		
76°F (24°C)		
80°F (27°C)		
84°F (29°C)		
88°F (31°C)		

Note: The temperature sensing accuracy of the HVAC Setback Module is only ensured when powered at 24VAC. If another voltage is used, such as 12VDC, an external temperature sensor is recommended for improved accuracy.

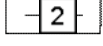
Note: The ability of the HVAC Setback Module to accurately sense ambient room temperature is highly dependent on where it is installed. Installing the device where it may be subject to local heat/cool sources, will distort the setback range accuracy.

To set a temperature range:





This examples shows changing the heat setback from Disabled to 62° F, and changing the cool setback from Disabled to 76° F.

1. Access Advanced Setup mode.    
2. Select the Heat Setback menu.    
3. Select an option.    
4. Save the selection.    
5. Select the Cool Setback menu.    
6. Select an option.    
7. Save the selection.    

Vacancy Check













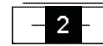



The vacancy check is a time delay that is activated when a door opens and closes. The linked loads will turn off, if the sensor(s) do not confirm occupancy within the time delay.

From the Vacancy Check menu, the active option is indicated by the number of green blinks on the Set LED; amber blinks indicate an unsaved change. Click the Set button an appropriate number of times to select an option.

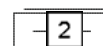
Option	Clicks	Blinks
5 mins. (default)	1	1 
15 minutes	2	2 
30 minutes	3	3 
60 minutes	4	4 
120 minutes	5	5 

To change the vacancy check option:



This example shows changing the option from 5 to 15 minutes.

1. Access Basic Setup mode.    
2. Select Vacancy Check menu.    
3. Select an option.    
4. Save the selection.    

To enable the device as a repeater

In some situations, enabling the transceiver device as a repeater can help optimize the wireless range between devices.

1. Access Advanced Setup by holding both buttons down for 5 seconds and releasing them when both LEDs turn amber.
2. Click the Set button an appropriate number of times to select an option. >> By default, the first menu option in advanced setup is to Enable Repeater.

Option	Clicks	Blinks
Disabled (default)	1	1 
1 Hop	2	2 
2 Hops	3	3 

Example: Setting a device to operate as a repeater.

1. Access the Advanced setup (hold down both buttons for 5 seconds - until both LEDs turn amber).
2. Select "option 2" by clicking the Set (right) button two times. (Set button LED will blink 2x (amber) to confirm)
3. Save selection by holding Set button for 2 seconds.
4. Exit Menu (hold both buttons for 2 seconds.)
5. Re-boot module by either power cycling or pressing and holding both buttons for 10 seconds (release when Left LED=Red, Right LED=Green).

Troubleshooting

Problem	Solution Checklist
The device does not power up	<ul style="list-style-type: none"> Check the wiring for errors Check the circuit breaker Use a voltage meter to confirm power
The device does not control linked load	<ul style="list-style-type: none"> Click the Set button to open/close the relay manually Turn off the power and then restore it
Cannot link other devices	<ul style="list-style-type: none"> Check if Accept Link option can be accessed Move closer to the device; it may be out of range Try linking a different device Check for environmental conditions that interfere with RF signals Verify the maximum number of devices (30) has not been exceeded
Cannot change settings on the device	<ul style="list-style-type: none"> Check if menu item can be accessed Check if changes can be saved
The device does not respond to wireless messages or selected settings	<ul style="list-style-type: none"> Check for environment or range issues Verify the device is linked Check if appropriate devices are linked according to good system planning Extend the antenna to amplify the range: remove it from the groove in the module, straighten it and slide it into the white antenna sleeve provided



Contains: FCC: SZV-STM300U (900 MHz) IC: 5713A-STM300U (900 MHz) FCC: SZV-STM300C (315 MHz) IC: 5713A-STM300C (315 MHz)

This device complies with part 15 of the FCC rules and Industry Canada ICES-003. Operation is subject to the following two conditions: (1) This device may not cause harmful interference, and (2) this device must accept any interference received, including interference that may cause undesired operation.

IMPORTANT! Any changes or modifications not expressly approved by the party responsible for compliance could void the user's authority to operate this equipment.

Le présent appareil est conforme aux CNR d'Industrie Canada applicables aux appareils radio exempts de licence. L'exploitation est autorisée aux deux conditions suivantes: (1) l'appareil ne doit pas produire de brouillage, et (2) l'utilisateur de l'appareil doit accepter tout brouillage radioélectrique subi, même si le brouillage est susceptible d'en compromettre le fonctionnement.

IMPORTANT! Tous les changements ou modifications pas expressément approuvés par la partie responsable de la conformité ont pu vider l'autorité de l'utilisateur pour actionner cet équipement.