

EMDCB – BLUETOOTH® MOTION DETECTOR AND LIGHT LEVEL SENSOR

---

## EMDCB (Revision DB)

Bluetooth Low Energy Motion Detector And Light Level Sensor



Observe precautions! Electrostatic sensitive devices!

Patent protected:

WO98/36395, DE 100 25 561, DE 101 50 128,  
WO 2004/051591, DE 103 01 678 A1, DE 10309334,  
WO 04/109236, WO 05/096482, WO 02/095707,  
US 6,747,573, US 7,019,241

## EMDCB – BLUETOOTH® MOTION DETECTOR AND LIGHT LEVEL SENSOR

**REVISION HISTORY**

The following major modifications and improvements have been made to this document:

Version	Author	Reviewer	Date	Major Changes
1.0	MKA	RS	14.12.2018	Initial release
1.1	MKA	MKA	18.02.2018	Added information on light sensor
1.2	MKA	MKA	07.06.2019	Added information on 2 Mbit mode
1.3	MKA	MKA	06.08.2019	Extended description of sensor functionality
1.4	MKA	MKA	24.03.2020	Update for product revision DA-04
1.5	MKA	MKA	04.12.2020	Update for product revision DA-05 Added ARIB certification
1.6	MKA	MKA	09.06.2021	Clarified default reporting configuration
2.0	MKA	RS, EG	02.08.2024	Update for product revision DB-09 Description of bi-color LED feedback
2.1	MKA	MKA	27.10.2025	Added Korea (KC) certification

**Published by EnOcean GmbH, Kolpingring 18a, 82041 Oberhaching, Germany  
www.enocean.com, info@enocean.com, phone +49 (89) 6734 6890**

© EnOcean GmbH, All Rights Reserved

**Important!**

This information describes the type of component and shall not be considered as assured characteristics. No responsibility is assumed for possible omissions or inaccuracies. Circuitry and specifications are subject to change without notice. For the latest product specifications, refer to the EnOcean website: <http://www.enocean.com>.

As far as patents or other rights of third parties are concerned, liability is only assumed for modules, not for the described applications, processes and circuits.

EnOcean does not assume responsibility for use of modules described and limits its liability to the replacement of modules determined to be defective due to workmanship. Devices or systems containing RF components must meet the essential requirements of the local legal authorities.

The modules must not be used in any relation with equipment that supports, directly or indirectly, human health or life or with applications that can result in danger for people, animals or real value.

**Recycling information**

Components of the modules are considered and should be disposed of as hazardous waste. Please use suitable recycling operators for modules, components or packaging.

## EMDCB – BLUETOOTH® MOTION DETECTOR AND LIGHT LEVEL SENSOR

**TABLE OF CONTENT**

1	General description.....	6
1.1	Basic functionality .....	6
1.2	Technical data.....	7
1.3	Environmental conditions .....	8
1.4	Packaging information.....	8
1.5	Ordering information .....	8
2	Functional description .....	9
2.1	EMDCB product overview.....	9
2.2	Start-up.....	9
2.3	Basic functionality .....	10
2.4	External product interface .....	10
2.5	Internal product interface.....	11
2.6	Functional modes .....	12
2.6.1	Standard Operation mode .....	12
2.6.2	Walk Test mode.....	12
2.6.3	Illumination Test mode.....	13
2.6.4	Standby (Sleep) mode.....	13
2.6.5	Factory Reset mode .....	13
2.7	Reporting interval.....	14
2.7.1	Unoccupied reporting interval.....	14
2.7.2	Occupied reporting interval .....	15
2.7.3	Illumination-controlled reporting interval .....	16
2.7.4	Arbitration between reporting intervals.....	16
3	Sensor functionality .....	17
3.1	Motion detection.....	17
3.1.1	PIR detection characteristics .....	17
3.2	Illumination measurement.....	18
3.2.1	Illumination measurement using the ambient light sensor.....	18
3.2.2	Illumination measurement using the solar cell .....	18
3.3	Energy level.....	19
3.4	Backup battery voltage .....	19
4	User interface .....	20
4.1	Bi-color LED.....	20
4.2	LRN button .....	20
4.2.1	LRN button timing indication .....	21
4.3	Sensitivity selection switch .....	22
4.4	Backup battery interface .....	22
4.4.1	Safety remarks.....	22
4.5	Product label.....	23
5	Radio transmission .....	24
5.1	Radio channel parameters .....	24

EMDCB – BLUETOOTH® MOTION DETECTOR AND LIGHT LEVEL SENSOR

- 5.2 Default radio transmission sequence ..... 25
- 5.3 User-defined radio transmission sequences ..... 26
  - 5.3.1 Three-channel sequence ..... 27
  - 5.3.2 Two-channel sequence ..... 27
  - 5.3.3 One-channel sequence ..... 28
- 6 Telegram format ..... 29
- 6.1 Preamble ..... 30
- 6.2 Access Address ..... 30
- 6.3 Header ..... 30
- 6.4 Source address ..... 30
  - 6.4.1 Static source address mode ..... 31
  - 6.4.2 Resolvable private address mode ..... 32
- 6.5 Check Sum ..... 33
- 6.6 Payload ..... 34
  - 6.6.1 Sensor status encoding ..... 35
  - 6.6.2 Sensor Data Descriptor ..... 35
  - 6.6.3 Data Size ..... 36
- 6.7 Supported parameters ..... 36
- 7 Telegram authentication ..... 37
- 7.1 Authentication implementation ..... 38
- 8 Commissioning ..... 39
- 8.1 Radio-based commissioning ..... 40
- 8.2 QR code commissioning ..... 40
  - 8.2.1 Commissioning QR code ..... 40
  - 8.2.2 Commissioning QR code format ..... 41
- 8.3 Commissioning via NFC interface ..... 41
- 9 NFC interface ..... 42
- 9.1 NFC interface parameters ..... 42
- 9.2 NFC access protection ..... 42
- 9.3 Using the NFC interface ..... 43
  - 9.3.1 PC with dedicated NFC reader ..... 43
  - 9.3.2 Android or iOS smartphone with NFC ..... 43
- 10 Installation recommendations ..... 44
- 10.1 Motion detection ..... 44
- 10.2 Illumination measurement ..... 45
- 10.3 Energy harvesting ..... 46
- 10.4 NFC configuration ..... 46
- 11 Regulatory notes ..... 47
- 11.1 European Union ..... 47
  - 11.1.1 Declaration of conformity ..... 47
  - 11.1.2 Waste treatment ..... 47
- 11.2 FCC (United States) ..... 48

EMDCB – BLUETOOTH® MOTION DETECTOR AND LIGHT LEVEL SENSOR

---

- 11.2.1 FCC (United States) certificate..... 48
- 11.2.2 FCC (United States) regulatory statement..... 49
- 11.2.3 FCC usage conditions ..... 49
- 11.2.4 FCC OEM requirements..... 50
- 11.3 ISED (Industry Canada) ..... 51
  - 11.3.1 ISED (Industry Canada) certificate..... 51
  - 11.3.2 ISED (Industry Canada) regulatory statement..... 52
- 11.4 ARIB (Japan) ..... 53
  - 11.4.1 ARIB certificate ..... 53
- 11.5 KC (Korea) Equipment Registration..... 54
  - 11.5.1 KC (Korea) product registration details..... 55
  - 11.5.2 KC (Korea) product registration logo ..... 55
- 12 License information ..... 56
- 13 Product history..... 57
- A Receiver configuration..... 58
  - A.1 Scanning parameters ..... 58
    - A.1.1 Advertising interval..... 59
    - A.1.2 Scan window..... 59
    - A.1.3 Scan interval..... 60
    - A.1.4 Summary ..... 60

EMDCB – BLUETOOTH® MOTION DETECTOR AND LIGHT LEVEL SENSOR

---

## 1 General description

This document describes EMDCB in product revision DB. For documentation about previous revisions of EMDCB, please contact EnOcean.

### 1.1 Basic functionality

EMDCB is a ceiling-mounted motion and illumination sensor that reports its status using Bluetooth Low Energy (BLE) advertising telegrams. It enables the realization of energy harvesting wireless occupancy and light level sensors for light, building or industrial control systems communicating with the 2.4 GHz Bluetooth Low Energy communication standard.

EMDCB uses a passive infrared (PIR) sensor to detect motion and a dedicated illumination sensor to measure the amount of ambient light.

EMDCB reports periodically (approximately every 2 minutes when no motion is detected, approximately every 1 minute when motion is detected) the latest detected motion (motion detected, no motion detected) together with the measured light level. EMDCB will report immediately if motion is detected for the first time after a period without detected motion (e.g. when a person is entering a room).

EMDCB can operate self-supplied via an integrated solar cell which generates the energy required for its operation. Self-supplied operation of EMDCB (no batteries required) requires 200 lux illumination for 6 hours per day.

For cases where ambient light is not sufficiently available, EMDCB provides the option to use a CR2032 backup battery.

Radio telegrams transmitted by EMDCB are authenticated AES-128 security based on a device-unique private key and a sequence counter. This ensures integrity and authenticity of the transmitted telegrams and prevents telegram replay (retransmission of previously transmitted telegrams).

## EMDCB – BLUETOOTH® MOTION DETECTOR AND LIGHT LEVEL SENSOR

## 1.2 Technical data

<b>Antenna</b>	Integrated antenna
<b>Output power</b>	+ 4 dBm
<b>Communication range (guidance only)</b>	75 m for ideal line of sight 10 m for indoor environment (line of sight)
<b>Communication standard</b>	BLE Advertising
<b>Radio frequency (min / max)</b>	2402 / 2480 MHz
<b>Radio channels (default)</b>	BLE CH 37 / 38 / 39 (2402 / 2426 / 2480 MHz) Configurable via NFC
<b>Data rate and modulation</b>	1 Mbit/s GFSK (BLE, default setting) 2 Mbit/s GFSK (Proprietary, can be selected via NFC)
<b>Motion detection radius</b>	Up to 5 m (16 ft.) when mounted 3 m (10 ft.) high
<b>Illumination measurement range</b>	0 ... 65000 lux (Sensor) 0 ... 1000 lux (Solar Cell)
<b>Illumination measurement accuracy</b>	+ -5% at full scale (Sensor) + -10% at 1000 lux (Solar Cell)
<b>Update rate with / without detected motion</b>	Approximately every 1 minute / every 2 minutes Initial motion detection is reported immediately Update rate is configurable via NFC
<b>User interface</b>	LRN button Bi-color notification LED Sensitivity selection switch
<b>Configuration interface</b>	NFC (ISO 14443)
<b>Device identification</b>	Unique 48 Bit Device ID (factory programmed)
<b>Security</b>	AES-128 CCM (RFC 3610)
<b>Power supply</b>	Integrated solar cell
<b>Required illumination to sustain operation</b>	6 hours per 24 hours at 200 Lux
<b>Charge time from empty to first transmission</b>	5 minutes at 400 Lux
<b>Out of box start-up time (standby to active)</b>	120 seconds
<b>Charge time from empty to full charge</b>	45 hours at 1000 Lux
<b>Operating time in darkness</b>	7 days (after full charge)
<b>Backup power supply (optional)</b>	CR2032
<b>Backup battery life</b>	
Infrequent bright light (200 lux for 2 hours every day)	15 years
Consistent low light (65 lux for 6 hours every day)	15 years
Total Darkness	5 years
<b>Dimensions</b>	113,2 mm L x 65,5 mm W x 30,7 mm H (4.46" L x 2.58" W x 1.21" H)
<b>Approvals</b>	CE / RED (EU) FCC (US) ISED (Canada) ARIB (Japan) KC (Korea)

## EMDCB – BLUETOOTH® MOTION DETECTOR AND LIGHT LEVEL SENSOR

---

### 1.3 Environmental conditions

<b>Maximum Operating Temperature<sup>(1)</sup></b>	-5 °C ... +45 °C / 25 ... 115 F (indoor use only)
<b>Recommended Operating Temperature<sup>(1)</sup></b>	0°C ... 30 °C / 32 ... 85 F (indoor use only)
<b>Humidity</b>	20 % r.h. ... 85 % r.h. (non-condensing)

Note 1: PIR detection requires that the environment is significantly colder than the moving object to be detected. Human motion detection therefore requires that the environment is significantly colder than the human body temperature of 36.5 °C / 98 F.

### 1.4 Packaging information

<b>Packaging Unit</b>	12 units
<b>Packaging Method</b>	Box / pallet

### 1.5 Ordering information

Type	Ordering Code	Frequency
<b>EMDCB-W-EO</b>	E6221-K515:DB	2.4 GHz (BLE)

EMDCB – BLUETOOTH® MOTION DETECTOR AND LIGHT LEVEL SENSOR

---

## 2 Functional description

### 2.1 EMDCB product overview

The energy harvesting ceiling-mounted motion and illumination sensor EMDCB from EnOcean provides wireless motion and illumination sensing functionality without batteries. Power is provided by a built-in solar cell harvesting available light from the environment.

EMDCB transmits sensor data based on the 2.4GHz Bluetooth Low Energy standard.

The outer appearance of EMDCB is shown in Figure 1 below.



**Figure 1 – EMDCB external view**

### 2.2 Start-up

Upon delivery, EMDCB is in standby (deep sleep) mode as described in Chapter 2.6.3 to conserve energy. To start operation, follow these steps:

1. Place EMDCB under bright light (outdoor or indoor)
2. Press the LRN button once to request start of operation
3. Leave under the selected light source for 5 minutes to provide an initial charge for operation

After that, EMDCB will be ready for operation and will blink every time when a telegram is transmitted.

EMDCB – BLUETOOTH® MOTION DETECTOR AND LIGHT LEVEL SENSOR

**2.3 Basic functionality**

EMDCB devices contain a passive infrared sensor that detects changes in the received infrared radiation which are characteristic for the movement of persons.

EMDCB integrates a solar cell that generates the required energy for its operation from available ambient light.

The user interface of EMDCB consists of one button for simple configuration tasks and one LED to provide user feedback. Configuration of EMDCB parameters is possible via an integrated NFC (ISO 14443) interface.

EMDCB is designed for ceiling mounting. It can be mounted on most ceilings with suitable screws or mounted on dropped ceilings using wire brackets.

**2.4 External product interface**

EMDCB uses a dedicated infrared lens in conjunction with a passive infrared sensor to detect motion.

EMDCB contains a dedicated sensor for illumination measurement. In addition, the integrated solar cell can also be used to measure the external light level. It also provides the required power for operation in normal lighting conditions.

The external user interface consists of one button (LRN) and one bi-color LED (located underneath the PIR lens) that together can be used for simple configuration and test activities. The internal NFC antenna (not visible from the outside) provides access to the NFC configuration interface.

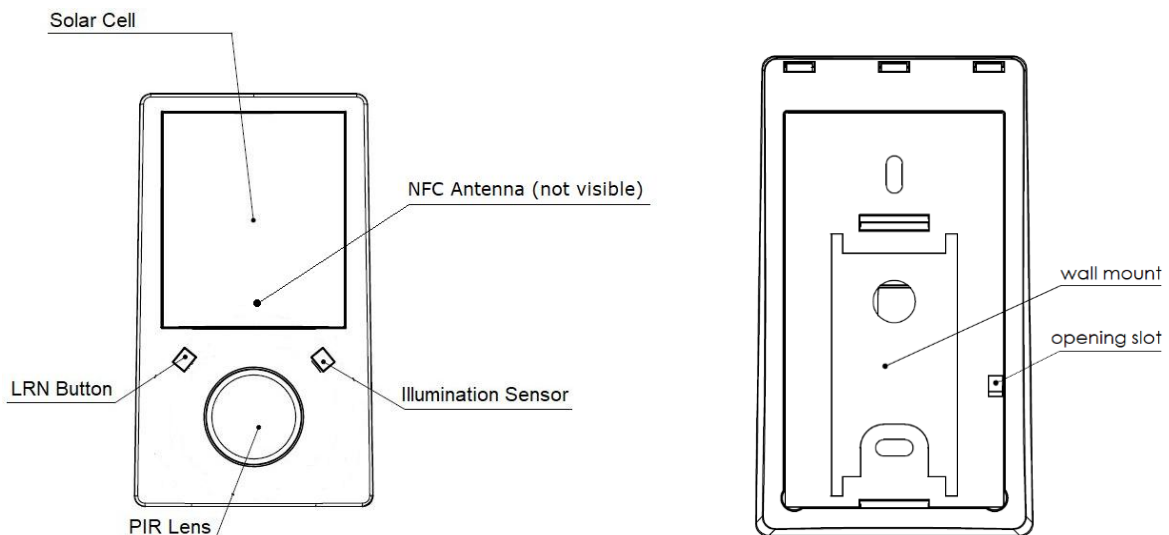
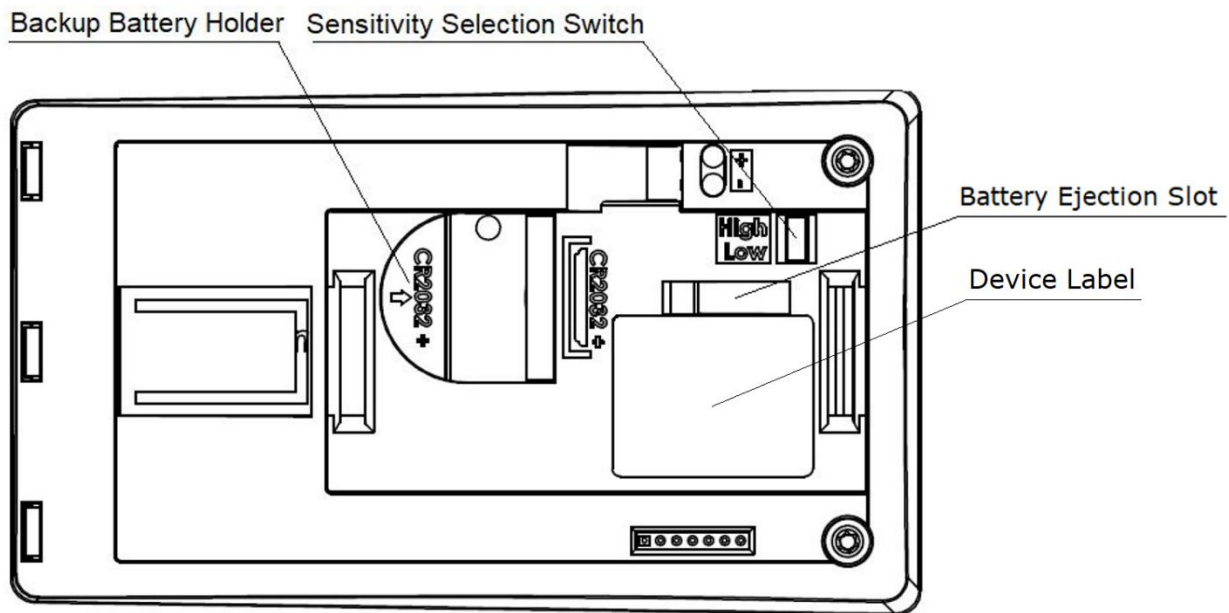

**Figure 2 – EMDCB front and rear view**

## EMDCB – BLUETOOTH® MOTION DETECTOR AND LIGHT LEVEL SENSOR

## 2.5 Internal product interface

EMDCB contains a holder for a CR2032 battery and a PIR sensitivity selection switch as shown in Figure 3 below.



**Figure 3 – EMDCB internal view**

The internal product interface is accessible after removing the wall mount plate. If EMDCB has not yet been mounted onto the ceiling, then the wall mount plate can be removed by using a screwdriver (or similar) with the opening slot. If the EMDCB wall mount plate is already attached to the ceiling, then EMDCB can be removed by gently pulling the housing.

EMDCB – BLUETOOTH® MOTION DETECTOR AND LIGHT LEVEL SENSOR

---

## 2.6 Functional modes

EMDCB supports five functional modes:

- Standard Operation mode
- Walk Test mode
- Illumination Test mode
- Standby (Sleep) mode
- Factory Reset mode

These modes are described below.

### 2.6.1 Standard Operation mode

During standard operation, EMDCB wakes up periodically and reports the current light level and motion detection status using data telegrams.

The motion detection functionality is described in chapter 3.1, the light level sensing functionality in chapter 3.2 and the data telegram transmission and format in chapters 0 and 6 respectively.

The EMDCB wake-up timer is configured to wake-up EMDCB approximately every 2 minutes during periods without detected motion and approximately every 1 minute during periods with detected motion. If motion is detected for the first time after a period without motion, then EMDCB wakes up immediately.

Both the occupied and the unoccupied wake-up intervals are affected at random to increase the robustness of the radio transmission and to comply with regulatory requirements.

It is possible to change the reporting intervals under specific conditions as described in chapter 2.7. In case of reducing the reporting interval, the resulting increase in required energy (provided by the available light or a backup battery) must be considered.

### 2.6.2 Walk Test mode

Walk test mode is used to verify the motion detection coverage of the device via periodic feedback from the LED. The LED will blink green if motion has been detected and red if no motion has been detected.

Walk test mode can be activated by using the LRN button as described in chapter 4.2 or by using NFC as described in chapter 9 and will be active for a period of 120 seconds.

Walk test mode can only be executed if the energy store of EMDCB is sufficiently charged. Alternatively, a backup battery can be fitted for the duration of the walk test mode.

EMDCB – BLUETOOTH® MOTION DETECTOR AND LIGHT LEVEL SENSOR

---

### 2.6.3 Illumination Test mode

During installation, EMDCB can measure and report the amount of ambient light available at its solar cell to determine a suitable installation location.

Activation of Illumination Test mode will be indicated by the LED of EMDCB using a green blink followed by a red blink.

Upon activation of Illumination Test mode, EMDCB will first wait for 20 seconds so that the installer can vacate the area in front of the sensor to ensure an accurate measurement result. EMDCB will indicate this waiting period using red blinks at a rate of one blink every 3 seconds.

After that, EMDCB will take measurements of the ambient light level using its solar cell every 5 seconds for a period of approximately one minute and indicate each measurement using a green blink.

After completion of the measurements, EMDCB will compute the average illumination based on those measurements. EMDCB will signal the completion of the Illumination Test using a green blink followed by a red blink and the computed average illumination can then be read-out via NFC interface as described in chapter 9.

### 2.6.4 Standby (Sleep) mode

Standby (Sleep) mode is used to conserve as much energy as possible during periods of storage or transport. All functionality – except those needed to return to standard operation mode – are disabled in this mode. Standby mode can be selected using the LRN button as described in chapter 4.2 or using the NFC interface as described in chapter 9.



When exiting standby mode, EMDCB requires an initialization time for the PIR sensor circuitry of up to 120 seconds before start of operation.

### 2.6.5 Factory Reset mode

The EMDCB configuration can be reset to the factory default values by means of a factory reset. Factory reset is triggered by pressing and holding the LRN button for more than 7 seconds as described in chapter 4.2 or by using the NFC interface as described in chapter 9.

## 2.7 Reporting interval

The reporting interval of EMDCB defines the interval between two status updates, i.e. between two data telegrams.

EMDCB allows using different reporting intervals for occupied status (motion is detected) and for unoccupied status (no motion is detected). Additionally, it is possible to define lower reporting intervals for the case that a certain light level is exceeded so that EMDCB reports more often for instance if a room is brightly lit.

The minimum possible reporting interval is 3 seconds, and the maximum possible transmission interval is 65535 seconds. Note that lowering the reporting intervals will increase power consumption. The default settings should therefore only be lowered if sufficient ambient light is available.

EMDCB will immediately report an initial motion detection after a period without detected motion independent of the selected configuration.

### 2.7.1 Unoccupied reporting interval

The unoccupied reporting interval determines the interval between two status updates of EMDCB while no motion is detected.

The default setting for the unoccupied reporting interval is one status update every 120 seconds (2 minutes). This interval can be adjusted using the NFC interface as described in chapter 9.

Figure 4 below illustrates the use of the unoccupied reporting interval.

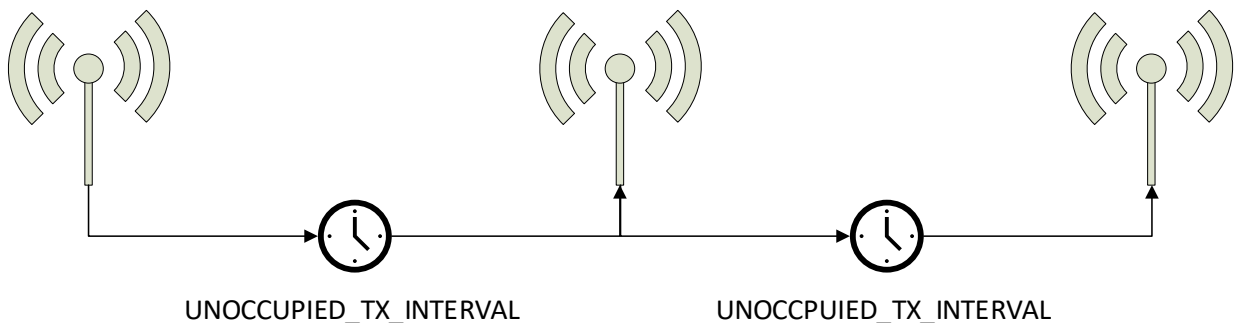

**Figure 4 – Unoccupied reporting interval**

EMDCB – BLUETOOTH® MOTION DETECTOR AND LIGHT LEVEL SENSOR

**2.7.2 Occupied reporting interval**

If a room is occupied, then it might be desirable to receive status updates more often for instance to report the current light level.

EMDCB is therefore by default configured to use a lower reporting interval, i.e. a higher update rate, while a room is occupied (i.e. while motion is detected). The default setting of the occupied reporting interval is 60 seconds. This setting can be changed using the NFC interface as described in chapter 9.

When a room becomes unoccupied (i.e. if motion is no longer detected), then EMDCB will send the first telegram indicating “unoccupied” status using the lower reporting interval. Subsequent updates will then again be sent using the higher unoccupied reporting interval.

Figure 5 below illustrates the use of the occupancy-controlled reporting interval.

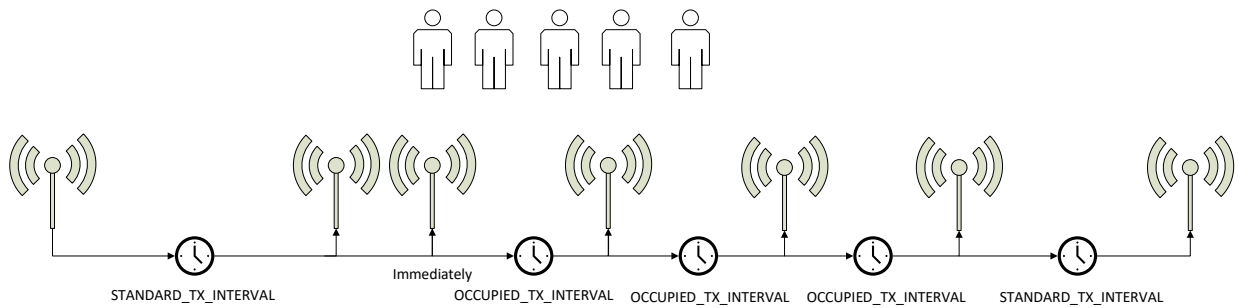

**Figure 5 – Occupied versus unoccupied reporting interval**

EMDCB – BLUETOOTH® MOTION DETECTOR AND LIGHT LEVEL SENSOR

### 2.7.3 Illumination-controlled reporting interval

If sufficient ambient light is available, then it might be desirable to receive status updates more often. For this, there are typically two main use cases:

- Adjust the update rate based on the ambient light available for harvesting
- Report more often during daytime (or when an office is lit) and less often during night-time (or when an office is dark) to adapt the reporting to the usage pattern

In both cases, the lower update rate (defined by the standard reporting interval) would be used whenever the ambient light level is below a certain threshold. The higher update rate (defined by the light level-controlled reporting interval) would be used whenever the ambient light level is above a certain threshold.

In these devices, the light threshold and the reporting interval rate to be used when the measured light level is above the threshold can be configured using the NFC interface as described in chapter 9.

It is possible to define different thresholds and reporting intervals for the solar cell (harvested energy) and the light level sensor (measured light level).

Figure 6 below illustrates the use of the illumination-controlled reporting interval.

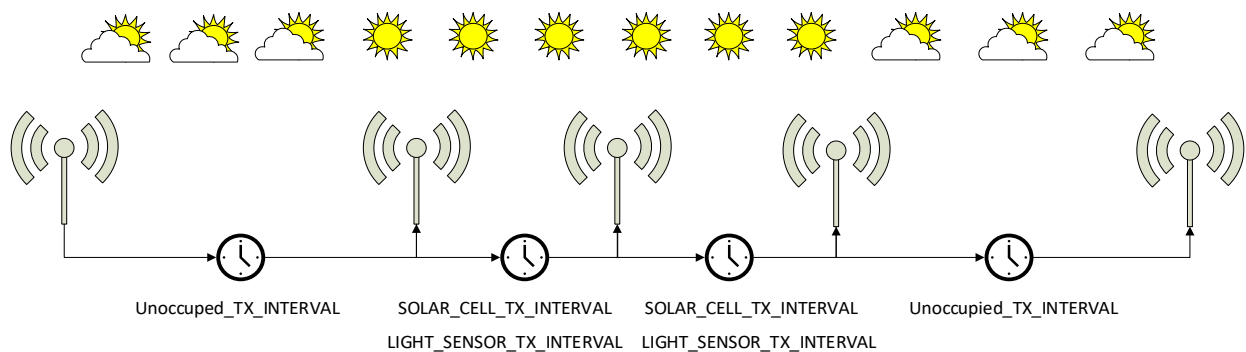

**Figure 6 – Illumination-controlled reporting interval**

### 2.7.4 Arbitration between reporting intervals

If more than one condition for a lower reporting interval applies – e.g. if a room is both occupied and brightly lit – then the lowest of the corresponding reporting intervals will be selected.

## EMDCB – BLUETOOTH® MOTION DETECTOR AND LIGHT LEVEL SENSOR

### 3 Sensor functionality

EMDCB implements the following sensor functions:

- Motion detection using the passive infrared sensor (PIR)
- Illumination measurement using the light level sensor
- Illumination measurement using the solar cell
- Energy level measurement for the internal energy store
- Supply voltage measurement for the backup battery (if present)

These functions are described in detail in the subsequent chapters.

#### 3.1 Motion detection

EMDCB contains an integrated passive infrared (PIR) sensor that can detect moving objects based on the temperature difference between the moving object and its environment.

##### 3.1.1 PIR detection characteristics

EMDCB is designed to detect movement within a radius of up to 5 m (16 ft.) when mounted at a ceiling of 3 m (10 ft.) height. The recommended coverage area for best detection performance is within a radius of 3 m (10 ft.).

Figure 7 below shows the PIR detection pattern.

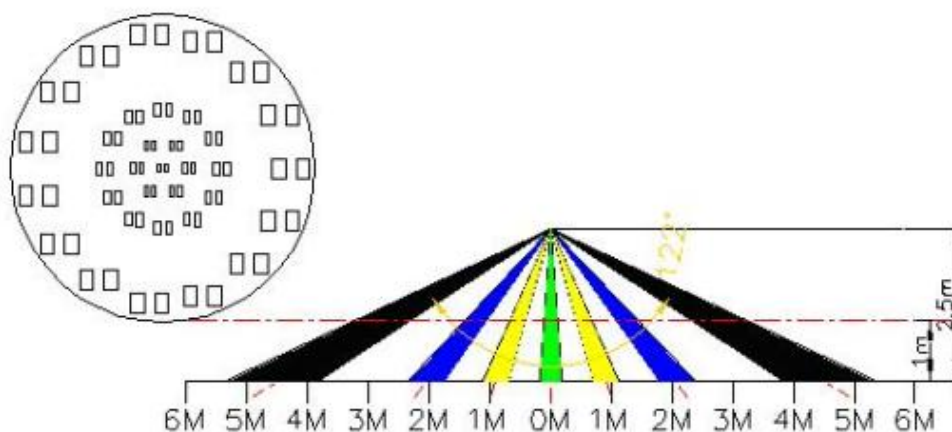

**Figure 7 – EMDCB PIR detection pattern**

## EMDCB – BLUETOOTH® MOTION DETECTOR AND LIGHT LEVEL SENSOR

### 3.2 Illumination measurement

EMDCB offers two options to measure and report the light level in the surrounding area. Each option serves different purposes, and their results can be different, depending on the surrounding circumstances. Refer to chapter 10.2 for a discussion about the respective benefits of the two options.

#### 3.2.1 Illumination measurement using the ambient light sensor

EMDCB integrates a dedicated ambient light sensor used to measure and report the light level directly underneath (for instance on the surface of a working desk).

This sensor has a narrow aperture and a spectral response optimized to mimic the human eye's perception of ambient light. It reports the light level directly underneath the sensor (spot measurement). Figure 8 shows the spectrum response of the EMDCB illumination sensor compared to that of the human eye.

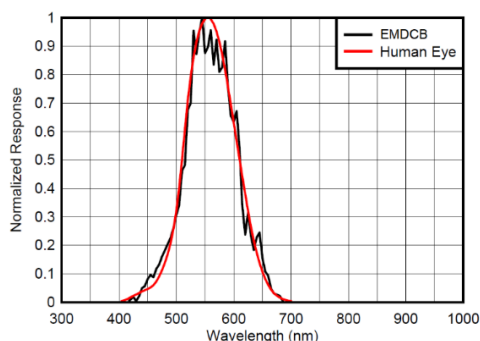

**Figure 8 – Spectrum response of the ambient light sensor**

Note that use cases such as light measurement on desk surfaces always require calibration on the receiver side to account for different light reflection characteristics. Use of the solar cell for illumination measurements – as described below – is recommended for applications where the average light level over a wider area should be measured.

#### 3.2.2 Illumination measurement using the solar cell

EMDCB can report the light level by measuring the energy generated by the solar cell.

This functionality can be used both to ensure that sufficient ambient light is available to power the device, to measure incoming light if the solar cell is oriented towards the window or to measure the light level over a wider area (e.g. if EMDCB is used wall-mounted). If mounted close and facing towards a window, EMDCB can serve well as a daylight sensor for lighting controllers when reporting the light level measured by the solar cell.

The solar cell has been factory calibrated for universal use and offers a wide field of view and a broad spectral sensitivity, covering LED, fluorescent, incandescent and natural light sources with a light level between 0 and 1000 lux.

### 3.3 Energy level

EMDCB can measure the voltage of the internal energy store which stores the harvested energy to supply the device when the ambient light is insufficient to power the device.

Based on the measured voltage, EMDCB will estimate the energy level (amount of remaining energy) and report this as a percentage between 0% (empty) and 100% (fully charged).

Reporting of the energy level can be enabled and disabled by using the NFC interface as described in chapter 9.

By default, the reporting of the remaining energy is enabled if no backup battery is present. If a backup battery is present, then by default its supply voltage is reported instead.

Note that the reported energy level can only provide rough guidance as the actual energy level depends on several factors (most notably the ambient temperature).

### 3.4 Backup battery voltage

EMDCB can measure the supply voltage level of external backup battery used to supply the device when the available ambient light is insufficient for energy harvesting operation.

Reporting of the backup battery voltage can be enabled and disabled by using the NFC interface as described in chapter 9.

By default, the backup battery voltage is reported if a backup battery is present. Otherwise, the energy level of the internal energy store is reported instead.

EMDCB – BLUETOOTH® MOTION DETECTOR AND LIGHT LEVEL SENSOR

## 4 User interface

The user interface of EMDCB consist of the following items:

- LRN button and Bi-color LED
- Sensitivity selection switch
- Backup battery interface

Please refer to chapters 2.4 and 2.5 to identify the location of these items.

### 4.1 Bi-color LED

EMDCB contains a bi-color indication LED used to provide user feedback. By default, the LED will blink shortly whenever a telegram indicating occupied (motion detected) status is sent. This indication can be disabled using the NFC interface as described in chapter 9.

In addition to that, the LED provides a response to LRN button inputs as described below.

### 4.2 LRN button

EMDCB device parameters can be configured using NFC interface as described in chapter 9.

Some of the most common parameters or states can additionally be configured using the LRN button with the LED providing visual feedback. Table 1 below lists those configuration actions.

Event / User Action	Action	LED Indication
<i>Telegram Transmission</i> (No Button Action)	<b>Data Telegram Transmission</b> Indication of data telegram transmission	1 blink red
<i>NFC Configuration</i> (Not Button Action)	<b>NFC Configuration Event</b> Configuration Update via NFC  Factory Reset via NFC	Config Success: 4 blink green Config Error: 4 blink red  Reset Success: 5 blink green Reset Error: 5 blink red
<i>Single Short Press</i> (Press < 1s)	<b>LRN Telegram Transmission</b> <i>If in Standard Operation Mode:</i> Send Commissioning Telegram  <i>If in Sleep Mode:</i> Wake up to Standard Operation Mode Send Commissioning Telegram	2 blink green   2 blink green

EMDCB – BLUETOOTH® MOTION DETECTOR AND LIGHT LEVEL SENSOR

<p><i>Double Short Press</i> (Each Press &lt;1s Pause in between &lt;1s)</p>	<p><b>Start Walk Test</b> Measure and report PIR sensor status every 3 seconds</p> <p>Indicate motion detection status via LED</p> <p>Function test ends after 2 minutes or upon button press</p>	<p>Start: 2 blink red-green</p> <p>Motion not detected: 1 blink red Motion detected: 1 blink green</p>
<p><i>Single Long Press</i> (Press 3s ... 5s)</p>	<p><b>Transition to Sleep Mode</b> <i>If in Sleep Mode:</i> Stay in Sleep Mode</p> <p><i>If in any other mode:</i> Enter Sleep Mode</p>	<p>3 blink red</p> <p>3 blink red</p>
<p><i>Double Long Press</i> (Each Press 3s ... 5s Pause in between &lt;1s)</p>	<p><b>Toggle LED Indication</b> <i>If LED Indication is Enabled:</i> Disable LED Indication</p> <p><i>If LED Indication is Disabled:</i> Enable LED Indication</p>	<p>4 blink red</p> <p>4 blink green</p>
<p><i>Single Very Long Press</i> (Press &gt;= 7s)</p>	<p><b>Factory Reset</b> Reset device configuration (to default configuration values)</p>	<p>Success: 5 blink green Insufficient energy: 5 blink red</p>

**Table 1 – EMDCB LRN button actions**

**4.2.1 LRN button timing indication**

To guide users regarding the expected duration of long and very long button presses, EMDCB will indicate the timing of a long button press by one short red blink and the timing of a very long button press by two red blinks as shown in Table 2.

<b>Type of press</b>	<b>Duration</b>	<b>LED Timing Indication</b>
Short	< 3 seconds	None
Long	> 3 seconds	One short red blink after 3 seconds
Very long	> 7 seconds	One short red blink after 3 seconds Two short red blinks after 7 seconds

**Table 2 – LED timing indication**

EMDCB – BLUETOOTH® MOTION DETECTOR AND LIGHT LEVEL SENSOR

---

### 4.3 Sensitivity selection switch

The sensitivity selection switch allows reducing the detection range from its default radius of up to 5 m to a reduced radius of up to 3 m.

Note that the exact detection radius depends on a number of factors including the mounting height and the ambient temperature.

### 4.4 Backup battery interface

The backup battery interface allows supplying EMDCB by means of a CR2032 battery in case the available ambient light is insufficient for energy harvesting operation. EnOcean recommends using Renata batteries due to their low self-discharge characteristics.

The CR2032 backup battery can be inserted by gently pushing it into the backup battery slot. Note that the positive terminal (+) must face upwards (away from the PCB). The backup battery can be removed by inserting a screwdriver into the battery ejection slot shown in Figure 3.

#### 4.4.1 Safety remarks

Please familiarize yourself with the following safety remarks before using a backup battery:



Do not insert any tools into the battery slot or the battery ejection slot. Doing so could create a short circuit or damage the PCB resulting in permanent damage.



CAUTION: Risk of damage or explosion if a battery of incorrect type is used. The battery shall be rated for operation up to 60°C.



This product can contain a coin/button cell battery. If the coin/button cell battery is swallowed, it can cause severe internal burns in just 2 hours and can lead to death.



Keep new and used batteries away from children.

EMDCB – BLUETOOTH® MOTION DETECTOR AND LIGHT LEVEL SENSOR

**4.5 Product label**

Each EMDCB contains a product label at the location indicated in Figure 3. The structure of the product label is shown in Figure 9 below. The product label contains a commissioning QR code in the lower left corner which is described in chapter 8.2.

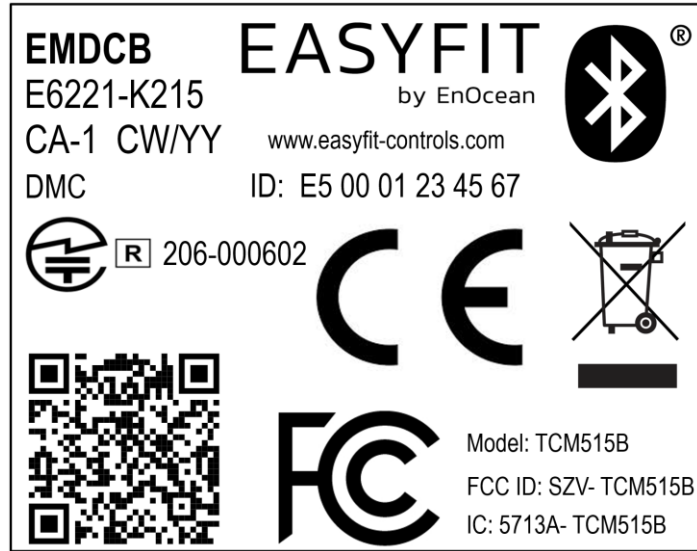

**Figure 9 – EMDCB device label**

EMDCB – BLUETOOTH® MOTION DETECTOR AND LIGHT LEVEL SENSOR

## 5 Radio transmission

### 5.1 Radio channel parameters

EMDCB transmits Bluetooth Low Energy (BLE) advertising telegrams within the 2.4 GHz radio frequency band (2402MHz ... 2480MHz).

By default, EMDCB will use the three BLE advertising channels (BLE Channel 37, 38 and 39) defined for transmission. The transmission of a radio telegram on these three advertising channels is called an Advertising Event.

Use of different radio channels within the frequency band from 2402 MHz to 2480 MHz is possible by using the NFC interface as described in chapter 9.

The initialization value for data whitening is set as follows:

- For BLE channels, it is set according to specification (value = radio channel)
- For the custom radio channels the initialization value is equal to the offset from 2400 MHz (e.g. value = 3 for 2403 MHz)

Table 3 below summarizes radio channels supported by EMDCB.

Radio Channel	Frequency	Channel Type
<b>BLE Radio Channels</b>		
37	2402 MHz	BLE Advertising Channel
0	2404 MHz	BLE Data Channel
1	2406 MHz	BLE Data Channel
...		
10	2424 MHz	BLE Data Channel
38	2426 MHz	BLE Advertising Channel
11	2428 MHz	BLE Data Channel
12	2430 MHz	BLE Data Channel
...		
36	2478 MHz	BLE Data Channel
39	2480 MHz	BLE Advertising Channel
<b>Custom Radio Channels</b>		
40	2403 MHz	Custom Radio Channel
41	2405 MHz	Custom Radio Channel
...		
77	2477 MHz	Custom Radio Channel
78	2479 MHz	Custom Radio Channel

**Table 3 – EMDCB supported radio channels**

EMDCB – BLUETOOTH® MOTION DETECTOR AND LIGHT LEVEL SENSOR

---

**5.2 Default radio transmission sequence**

EMDCB transmits telegrams in its standard configuration by using so-called Advertising Events.

An advertising event is defined as the transmission of the same radio telegram on all selected radio channels (by default this would be on BLE Channel 37, 38 and 39) one after another with minimum delay in between.

For reliability reasons, EMDCB will send three advertising events for each reporting event. The resulting transmission sequence is shown in Figure 10 below.

The default interval setting is 20 ms; an alternative setting of 10 ms can be configured by using the NFC interface as described in chapter 9.



**Figure 10 – Default radio transmission sequence**

### 5.3 User-defined radio transmission sequences

In certain situations, it might be desirable to transmit radio telegrams on channels other than the three advertising channels.

EMDCB therefore allows selecting the radio channels to be used for the transmission of data telegrams and commissioning telegrams. The following transmission modes are supported:

- Both commissioning telegrams and data telegrams are transmitted on the advertising channels as three advertising events. This is the default configuration and described in chapter 5.2 above.
- Commissioning telegrams are transmitted on the advertising channels as three advertising events while data telegrams are transmitted in a user-defined sequence as described below.
- Both commissioning and data telegrams are transmitted in a user-defined sequence as described below.

The selection of the transmission mode can be done by using the NFC interface as described in chapter 9.

EMDCB supports the following user-defined sequences:

- **Three-channel sequence**  
This sequence is similar to the default Advertising Event with the difference that the user can select the three radio channels to be used. The three-channel sequence is described in chapter 5.3.1 below.
- **Two-channel sequence**  
In this sequence the radio telegram is transmitted using six transmissions on two radio channels. It is described in chapter 5.3.2 below.
- **One-channel sequence**  
In this sequence the radio telegram is transmitted using nine transmissions on one radio channel. It is described in chapter 5.3.3 below.

### 5.3.1 Three-channel sequence

The three-channel radio transmission sequence is similar to the default transmission sequence with the difference that the radio channels (BLE Channel 37, 38 and 39 in the default transmission sequence) can be selected using the NFC interface as described in chapter 9.

In this mode, the telegram will be transmitted on the radio channel selected by CH\_REG1 first, immediately followed by a transmission on the radio channel selected by CH\_REG2 and a transmission on the radio channel selected by CH\_REG3.

The telegram will be transmitted using this sequence three times in total as shown in Figure 11 below.

This transmission uses a default INTERVAL setting of 20 ms; an alternative setting of 10 ms can be configured by using the NFC interface as described in chapter 9.



**Figure 11 – Three-channel radio transmission sequence**

### 5.3.2 Two-channel sequence

The two-channel radio transmission sequence transmits radio telegrams on two user-defined radio channels (selected by CH\_REG1 and CH\_REG2) six times in total.

The telegram will in this mode be transmitted on the radio channel selected by CH\_REG1 first, immediately followed by a transmission on the radio channel selected by CH\_REG2. This is shown in Figure 12 below.

This transmission sequence uses a default INTERVAL setting of 20 ms; an alternative setting of 10 ms can be configured by using the NFC interface as described in chapter 9.

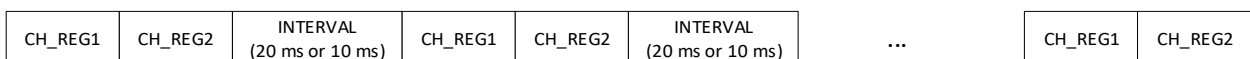
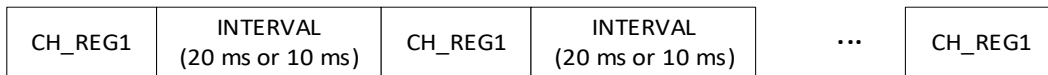

**Figure 12 – Two channel radio transmission sequence**

### 5.3.3 One-channel sequence

The one-channel radio transmission sequence transmits radio telegrams on one user-defined radio channel (selected by CH\_REG1) nine times in total. This is shown in Figure 13 below.

This transmission sequence uses a default INTERVAL setting of 20 ms; an alternative setting of 10 ms can be configured by using the NFC interface as described in chapter 9.



**Figure 13 – Single channel radio transmission sequence**

EMDCB – BLUETOOTH® MOTION DETECTOR AND LIGHT LEVEL SENSOR

## 6 Telegram format

In the standard configuration, EMDCB transmits Bluetooth Low Energy (BLE) advertising telegrams in the 2.4 GHz band.

For detailed information about the Bluetooth Low Energy standard in general and Bluetooth Advertising in particular, please refer to the applicable specifications.

Figure 14 below summarizes the BLE advertising frame structure.

Preamble 0xAA	Access Address 0x8E89BED6	Header (2 Byte)	Source Address (6 Byte)	Payload (0 ... 31 Byte)	Check Sum (3 Byte)
------------------	------------------------------	--------------------	----------------------------	----------------------------	-----------------------

**Figure 14 – BLE frame structure**

Figure 15 below shows specific properties used by EMDCB within the general BLE advertising frame structure.

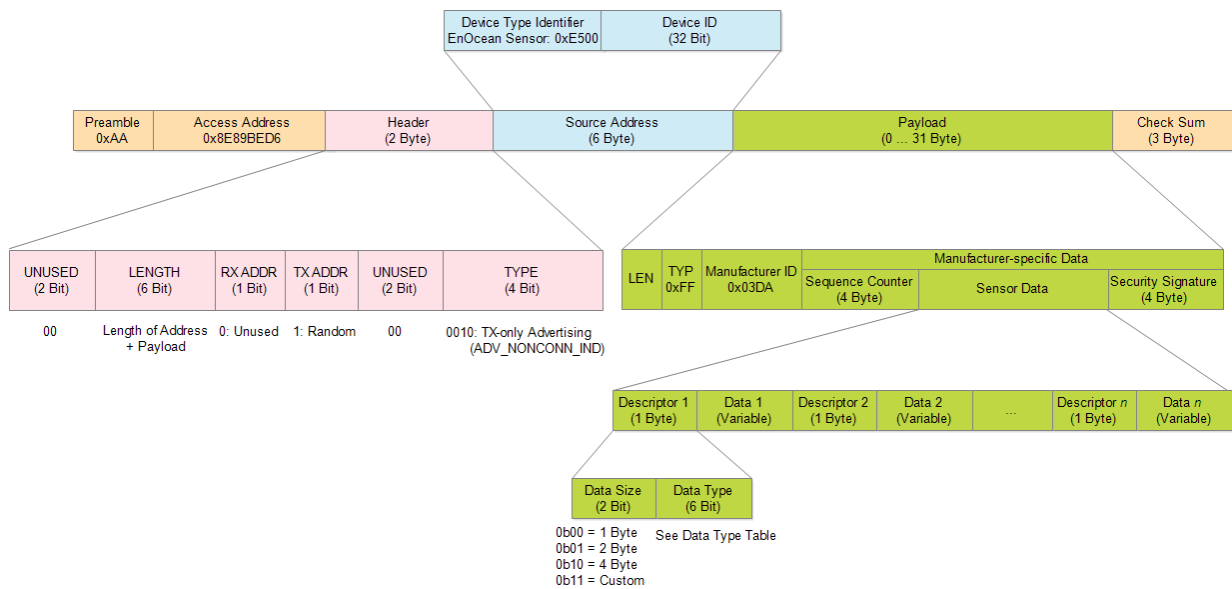

**Figure 15 – BLE frame structure**

The content of these fields is described in more detail below.

EMDCB – BLUETOOTH® MOTION DETECTOR AND LIGHT LEVEL SENSOR

### 6.1 Preamble

The BLE Preamble is 1 byte long and identifies the start of the BLE frame. The value of the BLE Preamble is always set to 0xAA.

### 6.2 Access Address

The 4 byte BLE Access Address identifies the radio telegram type. For advertising frames, the value of the Access Address is always set to 0x8E89BED6.

### 6.3 Header

The BLE Header identifies certain radio telegram parameters. Figure 16 below shows the structure of the BLE header.

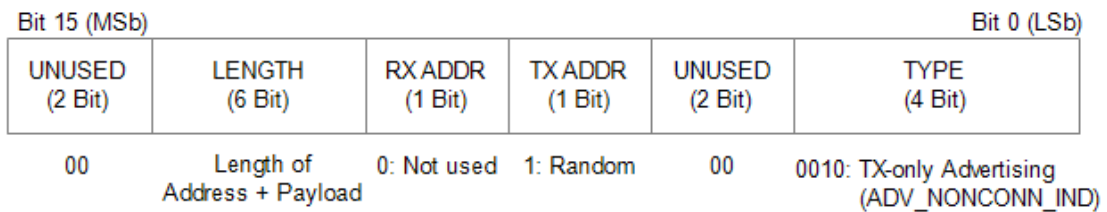

**Figure 16 – BLE header structure**

### 6.4 Source address

The 6 byte BLE Source Address (MAC address) uniquely identifies each EMDCB product. EMDCB supports two source address modes defined by the BLE standard:

- Static Source Address mode (default)  
In this mode, the source address is constant (but its lower 32 bit can be configured via NFC interface)
- Resolvable Private Address mode (NFC configurable)  
In this mode, the source address changes for each transmission according to a pre-defined scheme

EMDCB uses by default Static Source Address mode. Resolvable Private Address mode can be selected by using the NFC interface as described in chapter 9.

EMDCB – BLUETOOTH® MOTION DETECTOR AND LIGHT LEVEL SENSOR

**6.4.1 Static source address mode**

By default, EMDCB uses static source addresses meaning that the source address is constant during normal operation.

The structure of EMDCB static addresses is as follows:

- The upper 2 bytes of the source address are for EnOcean Bluetooth sensors always set to 0xE500 to enable filtering according to product type
- The lower 4 bytes are uniquely assigned to each device. They can be read and changed by using the NFC interface as described in chapter 9.

Figure 17 below illustrates the static address structure used by EMDCB.

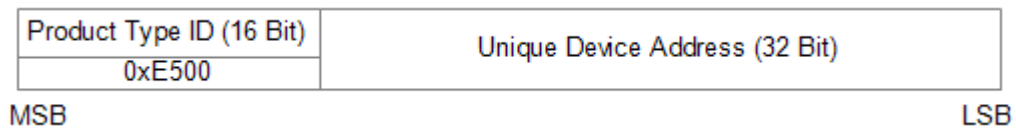

**Figure 17 – BLE static source address structure**

### 6.4.2 Resolvable private address mode

For some applications it is desirable to modify (rotate) the source address used by EMDCB in order to prevent tracking of its radio transmissions. At the same time, each EMDCB device must remain uniquely identifiable by the receiver. To achieve these goals, EMDCB can be configured via NFC to use resolvable private addresses (RPA).

Using resolvable private addresses requires that both EMDCB and the receiver both know a common key – the so-called Identity Resolution Key (IRK).

EMDCB uses its device-unique random key as identity resolution key. This key can be modified by using the NFC interface as described in chapter 9.

For resolvable private addresses, the 48 bit address field is split into two sub-fields:

- prand  
This field contains a random number which always starts (two most significant bits) with 0b10. The prand value is changed for each telegram that is transmitted. Individual advertising events used to transmit one telegram use the same prand value.
- hash  
This field contains a verification value (hash) generated from prand using the IRK

The structure of a random resolvable private address is shown in Figure 18 below.

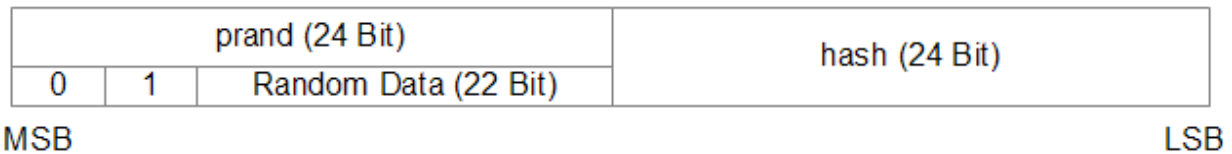

**Figure 18 – BLE private resolvable source address structure**

The prand value is encrypted using the IRK. The lowest 24 bit of the result (encrypted value) are then used as hash. The concatenation of 24 bit prand and 24 bit hash will be transmitted as 48 bit resolvable private address.

The receiver maintains a list of IRK for all transmitters that are known to it (have been commissioned to work with it). Whenever it receives a radio telegram with resolvable private address (identified by the most significant bits being set to 0b10), it will itself generate a 24 bit hash from the 24 bit prand sequentially using the IRK of each device that it has been learned into it. If an IRK matches (i.e. when prand is encoded with this specific IRK then the result matches hash), then the receiver has established the identity of the transmitter.

So conceptually the IRK takes the role of the device source address while prand and hash provide a mechanism to select the correct IRK among a set of IRK.

EMDCB – BLUETOOTH® MOTION DETECTOR AND LIGHT LEVEL SENSOR

Figure 19 below illustrates the address resolving scheme for random private addresses.

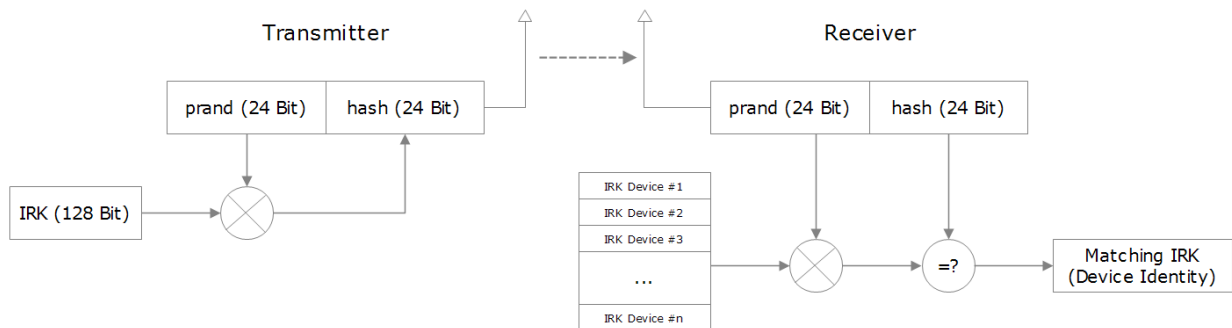

**Figure 19 – Resolving private source addresses**

Note that commissioning telegrams – as described in chapter 8.1 – will always use Static Source Addresses since they provide the identity resolution key required for resolving resolvable private addresses to the receiver.

### 6.5 Check Sum

The 3 byte BLE Check Sum is used to verify data integrity of received BLE radio telegrams. It is calculated as CRC (cyclic redundancy check) of the BLE Header, Source Address and Payload fields.

EMDCB – BLUETOOTH® MOTION DETECTOR AND LIGHT LEVEL SENSOR

### 6.6 Payload

The payload of EnOcean BLE sensor data telegrams can be up to 31 bytes long (depending on the size of the sensor data) and consists of the following fields:

- Length (1 byte)  
The *Length* field specifies the combined length of the following fields and depends on the size of the Sensor Status field. The minimum length is 13 byte and the maximum length is 31 byte
- Type (1 byte)  
The *Type* field identifies the data type used for this telegram. For EMDCB data telegrams, this field is always set to 0xFF to designate a manufacturer-specific data field
- Manufacturer ID (2 byte)  
The *Manufacturer ID* field is used to identify the manufacturer of BLE devices based on assigned numbers. EnOcean has been assigned 0x03DA as manufacturer ID code.
- Sequence Counter (4 byte)  
The *Sequence Counter* is a continuously incrementing counter used for security processing. It is initialized to 0 at the time of production and incremented whenever a telegram (data telegram or commissioning telegram) is sent.
- Sensor Data (variable size)  
The *Sensor Data* field reports the measured values of the sensors. The encoding of this field is described in chapter 6.6.1.
- Security Signature (4 byte)  
The *Security Signature* is used to authenticate EnOcean BLE sensor data telegrams, see chapter 7.

Figure 20 below illustrates the general telegram payload structure.

1 Byte	0xFF	Manufacturer ID 0x03DA	Sequence Counter (4 Byte)	Sensor Status (variable)	Security Signature (4 Byte)
LEN TYPE					

**Figure 20 – Telegram payload structure**

### 6.6.1 Sensor status encoding

The Sensor Status field within the Payload data identifies the status of the connected sensors. The Sensor Status field is composed of sub-fields (one per sensor attribute).

Each sub-field consists of two items:

- **Sensor Data Descriptor**  
The descriptor identifies the type of the attribute and the size of the following data field
- **Sensor Data**  
The sensor data encodes the attribute data

Figure 21 below shows the structure of the sensor status field.

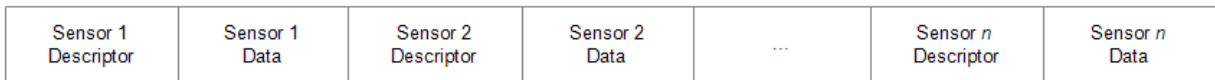

**Figure 21 – Sensor Status field structure**

### 6.6.2 Sensor Data Descriptor

The Sensor Data Descriptor describes type and size of the following sensor data field. It explicitly specifies the size to ensure forward compatibility, i.e. to enable future receivers to parse sensor telegrams containing unknown data types.

The Sensor Data Descriptor structure is shown in Figure 22 below.



**Figure 22 – Sensor Data Descriptor field structure**

The Sensor Data Descriptor explicitly specifies the data size to ensure forward compatibility for the case where an existing sensor does not “understand” subsequently introduced measurement parameters and therefore can’t determine the size of their data field.

In this case, the sensor can use the length information provided by this field to determine the start of the next sensor descriptor field (which might contain usable data).

EMDCB – BLUETOOTH® MOTION DETECTOR AND LIGHT LEVEL SENSOR

**6.6.3 Data Size**

The following values are possible for the Data Size field:

- 0b00 = 8 bit size (or implicit definition, e.g. commissioning telegram = 22 byte)
- 0b01 = 16 bit size
- 0b10 = 32 bit size
- 0b11 = Extended size, the first byte of the Sensor Data field specifies the size of the data (in byte) that follows (this feature is not used in EMDCB)

**6.7 Supported parameters**

EMDCB can report a variety of parameters. Some parameters are always reported while the reporting of other parameters can be enabled and disabled via NFC. Table 4 below summarizes the parameters that can be reported by EMDCB.

Standard Parameters (always reported)							
TYPE ID	Content	Size [byte]	Minimum	Maximum	Resolution	Unit	Encoding
0x05	Light level (sensor)	2	0	65 533	1	lx	16 bit unsigned int
0x20	Occupancy status	1	Enumeration (only specified values are valid) 0x01: Not occupied 0x02: Occupied				
0x3E	Commissioning info	22	16 byte AES key followed by 6 byte advertising address				
Optional Parameters (reporting enabled or disabled via NFC)							
0x01	Backup battery voltage (Disabled by default)	2	-16383	16383	0.5	mV	16 bit signed int
0x02	Energy level (Enabled by default)	1	0	100	0.5	%	8 bit (0...200) unsigned int
0x04	Light level (Solar cell) (Enabled by default)	2	0	65 533	1	lx	16 bit unsigned int
0x3C	Optional Data (Disabled by default)	0, 1, 2, 4	User-defined data				

**Table 4 – Supported parameters**

## 7 Telegram authentication

EMDCB implements telegram authentication to ensure that only telegrams from senders using a previously exchanged security key will be accepted. Authentication relies on a 32 bit telegram signature which is calculated as shown in Figure 23 below and exchanged as part of the radio telegram.

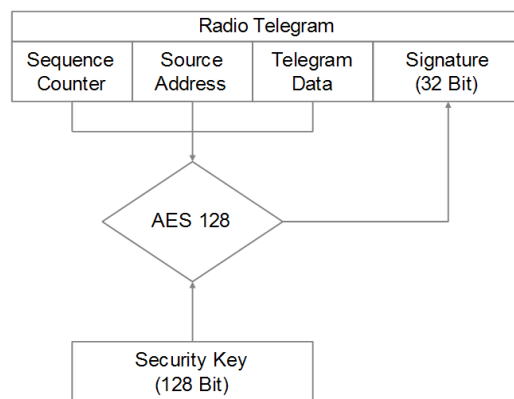

**Figure 23 – Telegram authentication flow**

Sequence counter, source address and the remaining telegram data together form the input data for the signature algorithm. This algorithm uses AES128 encryption based on the device-unique random security key to generate a 32 bit signature which will be transmitted as part of the radio telegram.

The signature is therefore dependent both on the current value of the sequence counter, the device source address and the telegram payload. Changing any of these three parameters will therefore result in a different signature.

The receiver performs the same signature calculation based on sequence counter, source address and the remaining telegram data of the received telegram using the security key it received from EMDCB during commissioning.

The receiver then compares the signature reported as part of the telegram with the signature it has calculated. If these two signatures match then the following statements are true:

- Sender (EMDCB) and receiver use the same security key
- The message content (address, sequence counter, data) has not been modified

At this point, the receiver has validated that the message originates from a trusted sender (as identified by its security key) and that its content is valid.

In order to avoid message replay (capture and retransmission of a valid message), it is required that the receiver tracks the value of the sequence counter used by EMDCB and only accepts messages with higher sequence counter values (i.e. not accepts equal or lower sequence counter values for subsequent telegrams).

EMDCB – BLUETOOTH® MOTION DETECTOR AND LIGHT LEVEL SENSOR

### 7.1 Authentication implementation

EMDCB implements telegram authentication based on AES128 in CCM (Counter with CBC-MAC) mode as described in IETF RFC3610. At the time of writing, the RFC3610 standard could be found here: <https://www.ietf.org/rfc/rfc3610.txt>

The 13 Byte CCM Nonce (number used once – unique) initialization value is constructed as concatenation of 6-byte Source Address, 4-byte Sequence Counter and 3-bytes of value 0x00 (for padding).

Note that both Source Address and Sequence Counter use little endian format (least significant byte first).

Figure 24 below shows the structure of the AES128 Nonce.

AES128 Nonce (13 Byte)												
Source Address						Sequence Counter				Padding		
Byte 0	Byte 1	Byte 2	Byte 3	Byte 4	Byte 5	Byte 0	Byte 1	Byte 2	Byte 3	0x00	0x00	0x00

**Figure 24 – AES128 Nonce structure**

The AES128 Nonce and the 128-bit device-unique security key are then used to calculate a 32-bit signature of the authenticated telegram data shown in Figure 25 below.

Source Address	Length	AD Type	Manufacturer ID		EnOcean Payload		
6 byte	1 byte	1 byte	2 byte		4 byte	1 ... 19 byte	4 byte
Variable	Variable	0xFF	0xDA	0x03	Sequence Counter	Switch / Sensor Data	Authentication Signature

**Figure 25 – Authenticated payload**

The calculated 32-bit signature is then appended to the data telegram.

## 8 Commissioning

Commissioning is the process by which EMDCB is learned into a receiver (actuator, controller, gateway, etc.).

The following two tasks are required in this process:

- **Device identification**  
The receiver needs to know how to uniquely identify this specific EMDCB device. This is achieved by using a unique 48 Bit ID (Source Address) for each EMDCB device.
- **Security parameter exchange**  
The receiver needs to be able to authenticate radio telegrams from EMDCB in order to ensure that they originate from this specific device and have not been modified. This is achieved by exchanging a 128 Bit random security key used by EMDCB to authenticate its radio telegrams.

EMDCB provides the following options for these tasks:

- **Radio-based commissioning**  
EMDCB can communicate its parameters via special radio telegrams (commissioning telegrams) to the intended receiver. Transmission of such telegrams can be triggered by using the LRN button as described in chapter 4.1.
- **QR code commissioning**  
Each EMDCB device contains a product label with an optically readable Quick Response (QR) Code which identifies its ID and its security key. This QR code can be read by a suitable commissioning tool (e.g. smartphone) which is already part of the network into which EMDCB will be commissioned. The commissioning tool then communicates these parameters to the intended receiver of EMDCB radio telegrams.
- **NFC commissioning**  
Each EMDCB device contains an NFC interface allowing to read device parameters and to configure the device.

## 8.1 Radio-based commissioning

Radio-based commissioning is used to associate EMDCB with other devices by sending a dedicated radio telegram (a so-called commissioning telegram).

To do so, EMDCB can transmit a dedicated commissioning telegram identifying its relevant parameters. The commissioning telegram will by default be transmitted on the BLE advertising channels (CH 37, 38 and 39). Use of custom radio channels is possible as described in chapter 5.3.

Commissioning telegrams will always use static source addresses mode; using resolvable private addresses for commissioning telegrams is not possible since they contain the security key required for resolving those addresses.

The transmission of the commissioning telegram is triggered by pressing the LRN button as described in chapter 4.1.

Radio-based commissioning mode is intended for applications where NFC commissioning cannot be used. Radio-based commissioning can be disabled via NFC.

## 8.2 QR code commissioning

Each EMDCB device contains a product label which can be used to commission EMDC. Refer to chapter 4.5 for a description of the product label.

### 8.2.1 Commissioning QR code

Each product label contains a commissioning QR code that can be scanned to identify source address and security key of EMDC to a receiver. Figure 26 shows an example of such QR code.



**Figure 26 – EMDCB Commissioning QR code**

EMDCB – BLUETOOTH® MOTION DETECTOR AND LIGHT LEVEL SENSOR

**8.2.2 Commissioning QR code format**

The QR code used in the new product label encodes the product parameter according to the ANSI/MH10.8.2-2013 industry standard. The QR code shown in Figure 26 above encodes the following string:

30SE50001234567+Z00112233445566778899AABBCCDDEEFF+30PE6221-K515+2PDA04+S01234567890123

Table 5 below describes the ANSI/MH10.8.2 data identifiers used by the EMDCB device label and shows the interpretation of the data therein.

Identifier	Length of data (excluding identifier)	Value
30S	12 characters	Static Source Address (hex)
Z	32 characters	Security Key (hex)
30P	10 characters	Ordering Code (E6221-K515)
2P	4 characters	Step Code - Revision (DA-04)
S	14 characters	Serial Number

**Table 5 – QR code format**

From this content, it is possible to extract the device address (E50000000C4) and the security key (9E0DE9C25386B6C4F070642E19E03680) which can then be used to commission EMDCB into a receiver and to authenticate EMDCB data telegrams as described in chapter 7.

**8.3 Commissioning via NFC interface**

EMDCB implements NFC Forum Type 2 Tag functionality as specified in the ISO/IEC 14443 Part 2 and 3 standards. The device address and the security key of EMDCB can be read by using the NFC interface as described in chapter 9.

## 9 NFC interface

EMDCB implements an NFC configuration interface that can be used to access (read and write) the EMDCB configuration memory.

NFC communication distance is for security reasons set to require direct contact between the NFC reader and the EMDCB device.



Note that EMDCB temporarily stops operation while the NFC reader is connected to the NFC interface of EMDCB to ensure configuration data integrity.

EMDCB operation will automatically resume approximately 5 seconds after the NFC reader has been disconnected.

### 9.1 NFC interface parameters

The NFC interface of EMDCB uses NFC Forum Type 2 Tag functionality as specified in the ISO/IEC 14443 Part 2 and 3 standards. It is implemented using an NXP NT3H2111 Mifare Ultralight tag.

### 9.2 NFC access protection

Protected data access is only possible after unlocking the configuration memory with the correct 32 bit PIN code. By default, the protected area is locked and the default pin code for unlocking access is `0x0000E500`.

The default pin code shall be changed to a user-defined value as part of the installation process.

## EMDCB – BLUETOOTH® MOTION DETECTOR AND LIGHT LEVEL SENSOR

### 9.3 Using the NFC interface

Using the NFC interface requires the following:

- NFC reader  
This can be either a USB NFC reader connected to a PC or a suitable smartphone with NFC functionality
- NFC SW with read, write, PIN lock, PIN unlock and PIN change functionality  
This can be either a PC application or an Android / iOS app

These options are described in more detail below.

#### 9.3.1 PC with dedicated NFC reader

For PC-based applications, EnOcean provides a dedicated PC application called EnOcean NFC configurator which works in conjunction with the TWN4 Multitech 2 HF NFC Reader.

EnOcean NFC Configurator can be obtained available from the EnOcean homepage:  
<https://www.enocean.com/en/product/enocean-nfc-configurator/>

The TWN4 Multitech 2 HF NFC Reader is available from Elatec RFID Systems ([sales-rfid@elatec.com](mailto:sales-rfid@elatec.com)) using order code T4BT-FB2BEL2-SIMPL. It is shown in Figure 27 below.



**Figure 27 – Elatec TWN4 MultiTech Desktop NFC Reader**

#### 9.3.2 Android or iOS smartphone with NFC

NFC functionality is available in most Android (e.g. Samsung Galaxy S7 or newer) and iOS (starting from iPhone7 with firmware version 13 or newer) smartphones.

EnOcean provides the configuration app “EnOcean Tool” for these devices which can be downloaded directly from the respective app store.

At the time of writing, the tool was available from the Google Play Store using this link:  
<https://play.google.com/store/apps/details?id=de.enocean.easytool&hl=en>

Likewise, the tool was available from the Apple Store using this link:  
<https://apps.apple.com/de/app/enocean-tool/id1497283202>

EMDCB – BLUETOOTH® MOTION DETECTOR AND LIGHT LEVEL SENSOR

---

## 10 Installation recommendations

### 10.1 Motion detection

Motion detection works based on the temperature difference between a moving object and its environment. Detection accuracy can therefore be affected by the following factors:

- Insufficient temperature difference (leading to no detection)
- Obstructions between PIR detector and moving person (leading to no detection)
- Warm moving objects (leading to false detections)
- Electro-magnetic radiation

For the case of person detection, the temperature of the moving object is the human body temperature (normally around 36.5 °C / 98 F). If under very hot conditions the temperature of the environment approaches the temperature of the human body, then detection performance will be significantly reduced.

For the same reason, hot objects within the detection area should be avoided. Examples include standing lights, heaters or electrical equipment generating heat.

To reliably detect motion, an unobstructed line of sight from the sensor to the person(s) in the detection area is required. Walls, room dividers, plants, book shelves, hanging lights or other obstacles within the line of sight can limit the detection performance.

The following factors should be considered to avoid the unintended detection of other warm moving objects:

- Rapid temperature changes in the vicinity of the PIR detector, e.g. caused by fans or fan heaters being switched on or off
- Lights (especially incandescent or halogen) being switched on or off in the immediate catchment area
- Warm moving objects such as animals, machines (e.g. cleaning robots or toys), hot paper output of fax machines and laser printers, falling flower petals
- Motion in areas adjacent to the intended detection area, e.g. in the floor or in the aisle around the detection area or outside of the window

Strong external electro-magnetic fields might induce noise into the highly sensitive PIR detection circuitry and thereby affect the detection performance. EMDCB should therefore not be mounted in close vicinity of electro-magnetic radiation sources such as Wi-Fi access points, gateways, wireless audio or video systems or other wireless devices.

For consistent detection, the mounting site of EMDCB should not be exposed to vibrations or motion.

EMDCB – BLUETOOTH® MOTION DETECTOR AND LIGHT LEVEL SENSOR

---

## 10.2 Illumination measurement

The dedicated illumination sensor integrated into EMDCB accurately measures and report the light level directly underneath (e.g. on the desk surface) with a spectral response close to the human eye's perception of ambient light.

The following points should be considered when using the illumination sensor:

- **Aperture**  
The sensor measures the light level within a small radius directly underneath it. If the lighting conditions within that area are not representative for the overall conditions, then the result might be different from expectation.
- **Surface**  
The most common application for a ceiling-mounted illumination sensor is to measure the light level at a working desk surface underneath. In this application, the measured light level depends on the reflectivity of the surface  
Simply put, a dark desk surface will give a totally different result compared to a white desk surface even when the same luminous flow is directed towards it.
- **Obstruction**  
Any obstruction between the sensor and the intended measurement area (desk surface, window) will significantly impact the measurement result. Maintaining a clear line of sight between measurement area and illuminations sensor is therefore essential.
- **Interference**  
To ensure accurate measurement results, it is essential to minimize interference from other light sources not contributing to the illumination at the target measurement area.  
For instance, when measuring the light level at a desk surface, interference might occur due to direct light from the window or from or upwards emission of indirect light sources (floor lamps etc)

Consider using the light level reported by the solar cell as an alternative approach if measuring a light level over a wider area is desired.

EMDCB – BLUETOOTH® MOTION DETECTOR AND LIGHT LEVEL SENSOR

---

### 10.3 Energy harvesting

EMDCB is powered by ambient light using its integrated solar cell. For best performance it is therefore essential to maximize the amount of light available for harvesting.

Harvestable light will typically be either natural light (daylight coming in through windows etc) or artificial light (direct or reflected light from indoor luminaires). If natural light is available (e.g. from a window) then the solar cell of EMDCB should be oriented as much as possible towards that.

As guidance it can be assumed that the mandated light level of 300 lux at office desk surfaces will in most cases result in sufficient available light for operation of EMDCB with its standard parameters.

If the available light is insufficient, then EMDCB offers the option to configure a lower reporting rate via NFC as discussed in chapter 2.7 or to use a CR2032 backup battery as described in chapter 4.4.

### 10.4 NFC configuration

EMDCB can be flexibly configured for a wide range of application scenarios using the NFC configuration interface as described in chapter 9.



Updating the device configuration via the NFC interface requires that EMDCB has sufficient energy to read and process the new parameters.

It is therefore recommended to provide an initial charge to EMDCB by placing it under bright light for 5 minutes before starting the configuration process.

Before making any configuration changes, be sure to familiarize yourself with the device functionality and determine the energy constraints based on the available ambient light. Be especially careful not to configure high update rates (low reporting intervals) before ensuring that sufficient light is available.

Should you be unsure about the current NFC configuration then execute a factory reset as described in chapter 2.6.5 to reset all configuration registers to their default setting.

After completing the NFC configuration and ensuring that all functionality works as required, it is recommended to lock the NFC configuration interface by changing the NFC PIN code from its default value to a different (secret) value. Make sure the new PIN code is properly noted down.

## 11 Regulatory notes

### 11.1 European Union

#### 11.1.1 Declaration of conformity

Hereby, EnOcean GmbH, declares that this radio equipment is in compliance with the essential requirements and other relevant provisions of Directive 2014/53/EU. A copy of the Declaration of Conformity can be obtained from the product webpage at [www.enocean.com](http://www.enocean.com)

#### 11.1.2 Waste treatment

##### WEEE Directive Statement of the European Union

The marking below indicates that this product should not be disposed with other household wastes throughout the EU. To prevent possible harm to the environment or human health from uncontrolled waste disposal, recycle it responsibly to promote the sustainable reuse of material resources.

Germany: WEEE-Reg-No.: DE 93770561

##### BATTERY Directive

The symbol below indicates that batteries must not be disposed of in the domestic waste as they contain substances which can be damaging to the environment and health. Please dispose of batteries in designated collection points.

Germany: BattDG-Reg-No.: DE 96461173



##### Warning

Do not dispose of the product in fire, at extremely high temperatures or by mechanical crushing!

EMDCB – BLUETOOTH® MOTION DETECTOR AND LIGHT LEVEL SENSOR

## 11.2 FCC (United States)

### 11.2.1 FCC (United States) certificate

**TCB**

**GRANT OF EQUIPMENT  
AUTHORIZATION**

**TCB**

**Certification  
Issued Under the Authority of the  
Federal Communications Commission  
By:**

**EMCCert Dr. Rasek GmbH  
Stoernhofer Berg 15  
91364 Unterleinleiter,  
Germany**

**Date of Grant: 12/15/2017  
Application Dated: 12/15/2017**

**EnOcean GmbH  
Kolpingring 18a  
Oberhaching, 82041  
Germany**

**Attention: Armin Anders , Director Product Marketing**

**NOT TRANSFERABLE**

EQUIPMENT AUTHORIZATION is hereby issued to the named GRANTEE, and is VALID ONLY for the equipment identified hereon for use under the Commission's Rules and Regulations listed below.

**FCC IDENTIFIER: SZV-TCM515B**  
**Name of Grantee: EnOcean GmbH**  
**Equipment Class: Digital Transmission System**  
**Notes: 2.4 GHz Bluetooth Low Energy (BLE) Transceiver**  
**Modular Type: Single Modular**

<u>Grant Notes</u>	<u>FCC Rule Parts</u>	<u>Frequency Range (MHZ)</u>	<u>Output Watts</u>	<u>Frequency Tolerance</u>	<u>Emission Designator</u>
	15C	2402.0 - 2480.0	0.003		

Power output listed is peak conducted. This device and its antenna(s) must not be co-located or operating in conjunction with any other antenna or transmitter except in accordance with FCC accepted multi-transmitter procedures.

In addition to the 40 BLE channels, further 39 channels within the ISM band are available, activated by an application software or the external host.

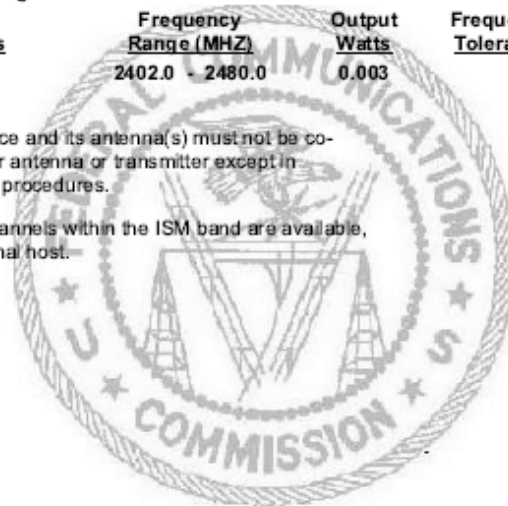

### **11.2.2 FCC (United States) regulatory statement**

This device complies with part 15 of the FCC Rules. Operation is subject to the following two conditions:

- (1) this device may not cause harmful interference, and
- (2) this device must accept any interference received, including interference that may cause undesired operation.

### **11.2.3 FCC usage conditions**

TCM 515B is a RF module approved for Single Modular use. It is incorporated into EMDCB as OEM installation using an approved antenna.

The module is optimized to operate using small amounts of energy, and may be powered by a battery. The module transmits short radio packets comprised of control signals, (in some cases the control signal may be accompanied with data) such as those used with alarm systems, door openers, remote switches, and the like.

The module does not support continuous streaming of voice, video, or any other forms of streaming data; it sends only short packets containing control signals and possibly data. The module is designed to comply with, has been tested according to 15.231(a-c), and has been found to comply with each requirement.

Thus, EMDCB containing the TCM 515B radio module can be operated in the United States without additional Part 15 FCC approval (approval(s) for unintentional radiators may be required for the OEM's finished product), under EnOcean's FCC ID number if the OEM requirements are met.

#### 11.2.4 FCC OEM requirements

In order to use EnOcean's FCC ID number, the OEM must ensure that the following conditions are met:

- The Original Equipment Manufacturer (OEM) must ensure that FCC labeling requirements are met. This includes a clearly visible label on the outside of the final product. Attaching a label to a removable portion of the final product, such as a battery cover, is not permitted.
- The label must include the following text:  
*Contains FCC ID: SZV-TCM515B*  
*The enclosed device complies with Part 15 of the FCC Rules. Operation is subject to the following two conditions: (i.) this device may not cause harmful interference and (ii.) this device must accept any interference received, including interference that may cause undesired operation.*
- The FCC identifier or the unique identifier, as appropriate, must be displayed on the device.
- The user manual for the end product must also contain the text given above.

EMDCB – BLUETOOTH® MOTION DETECTOR AND LIGHT LEVEL SENSOR

11.3 ISED (Industry Canada)

11.3.1 ISED (Industry Canada) certificate



FCB under the Canada-EC MRA  
 TCB under the USA-EC MRA  
 RFCAB under the Japan-EC MRA  
 Notified Body RE Directive 2014/53/EU  
 Notified Body EMC Directive 2014/30/EU

No. CA001791J

TECHNICAL ACCEPTANCE  
 CERTIFICATE  
 CANADA

CERTIFICAT D'ACCEPTABILITÉ  
 TECHNIQUE  
 CANADA

CERTIFICATION No. 5713A-TCM515B  
 No. DE CERTIFICATION  
 ISSUED TO EnOcean GmbH  
 DELIVRE A

Street Address Kolpingring 18 a  
 Numéro et rue  
 Province or State Germany  
 Province ou Etat

City Oberhaching  
 Ville  
 Postal Code 82041  
 Code postal

TYPE OF EQUIPMENT Bluetooth Device, Modular Approval  
 GENRE DE MATERIEL

PMN TCM 515B  
 HVIN TCM 515B  
 FVIN N/A

ANTENNA Integrated ANTENNA GAIN max. 5 dBi  
 ANTENNE Incorporé GAIN D'ANTENNE

FREQUENCY RANGE BANDE DE FRÉQUENCES	EMISSION TYPE GENRE D'ÉMISSION	RF POWER PUISSANCE H.F.	SPECIFICATION / ISSUE / DATE SPÉCIFICATION / ÉDITION / DATE
2402 - 2480 MHz	1M10G1D	0.003 Watt	R55-247 / 2 / February 2017

TEST LABORATORY EMCCons DR. RAŠEK GmbH & Co. KG  
 LABORATOIRE D'ESSAY

Street Address Störnhofer Berg 15  
 Numéro et rue  
 Province or State Germany  
 Province ou Etat

CN 3464C OATS 3464C-1  
 City Unterleinleiter  
 Ville  
 Postal Code 91364  
 Code Postal

Name Ludwig Kraft  
 Nom  
 E-mail lkraft@emcc.de

Tel +49 9194 7263-301  
 Fax +49 9194 7263-309

Certification of equipment means only that the equipment has met the requirements of the above-noted specification. Licence applications, where applicable to use certified equipment, are acted on accordingly by the ISED issuing office and will depend on the existing radio environment, service and location of operation. This certificate is issued on condition that the holder complies and will continue to comply with the requirements and procedures issued by ISED. The equipment for which this certificate is issued shall not be manufactured, imported, distributed, leased, offered for sale or sold unless the equipment complies with the applicable technical specifications and procedures issued by ISED.

La certification du matériel signifie seulement que le matériel a satisfait aux exigences de la norme indiquée ci-dessus. Les demandes de licences nécessaires pour l'utilisation du matériel certifié sont traitées en conséquence par le bureau de délivrance d'ISDE et dépendent des conditions radio ambiantes, du service et de l'emplacement d'exploitation. Le présent certificat est délivré à la condition que le titulaire satisfasse et continue de satisfaire aux exigences et aux procédures d'ISDE. Le matériel à l'égard duquel le présent certificat est délivré ne doit pas être fabriqué, importé, distribué, loué, mis en vente ou vendu à moins d'être conforme aux procédures et aux spécifications techniques applicables publiées par ISDE.

I hereby attest that the subject equipment was tested and found in compliance with the above-noted specification.

J'atteste par la présente que le matériel a fait l'objet d'essai et jugé conforme à la spécification ci-dessus.

DATE 15 December 2017

Certification Officer

### **11.3.2 ISED (Industry Canada) regulatory statement**

This device complies with Industry Canada licence-exempt RSS standard(s). Operation is subject to the following two conditions:

- (1) this device may not cause interference, and
- (2) this device must accept any interference, including interference that may cause undesired operation of the device.

Le présent appareil est conforme aux CNR d'Industrie Canada applicables aux appareils radio exempts de licence. L'exploitation est autorisée aux deux conditions suivantes :

- (1) l'appareil ne doit pas produire de brouillage, et
- (2) l'utilisateur de l'appareil doit accepter tout brouillage radioélectrique subi, même si le brouillage est susceptible d'en compromettre le fonctionnement."

## EMDCB – BLUETOOTH® MOTION DETECTOR AND LIGHT LEVEL SENSOR

### 11.4 ARIB (Japan)

#### 11.4.1 ARIB certificate



Notified Body EMC Directive 2014/30/EU  
 Notified Body Directive 2014/53/EU  
 RF CAB under the Japan-EC MRA  
 FCB under the Canada-EC MRA  
 TCB under the USA-EC MRA

RF CAB ID No. 206

Designated by the German Regulator Bundesnetzagentur to act as a  
 Recognised Foreign Conformity Assessment Body in accordance with the Japan-EC MRA

### CONSTRUCTION TYPE CONFORMITY CERTIFICATE for Specified Radio Equipment

Registration No.	JU000602M
Certificate Holder	EnOcean GmbH Kolpingring 18a 82041 Oberhaching Germany
Product Category	Article 2, Paragraph 1, Item 19 (WW)
Product Designation	TCM 515B, STM 550B, EMSIB, EMDCB
Product Description	Bluetooth Low Energy Transmitter
Software Release No.	1.4.0.1
Manufacturer	Katek GmbH Bahnhofstraße 108 83224 Grassau Germany

When the product is placed on the Japanese market, it must carry the Specified Radio Equipment marking as shown on the right

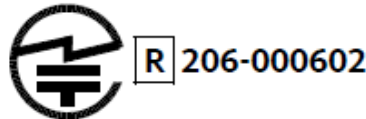

The scope of evaluation relates to the submitted documents only.

This Certificate confirms that the listed product has demonstrated conformity with the relevant technical regulations defined in the attached Annex. It is only valid in conjunction with the Annex.

Unterleinleiter,  
 2020-04-06

  
 \_\_\_\_\_  
 Ludwig Kräft  
 Recognised Foreign Conformity Assessment Body

EMDCB – BLUETOOTH® MOTION DETECTOR AND LIGHT LEVEL SENSOR

11.5 KC (Korea) Equipment Registration

SBFC-E23F-E8E3-05E6

방송통신기자재등의 적합등록증 <i>Registration of Broadcasting and Communication Equipments</i>	
상호 또는 성명 Trade Name or Registrant	EnOcean GmbH
기자재명칭(제품명칭) Equipment Name	Bluetooth Low Energy Motion Detector And Light Level Sensor
기기부호/추가 기기부호 Equipment code /Additional Equipment code	LARN8
기본모델명 Basic Model Number	EMDCB
파생모델명 Series Model Number	
등록번호 Registration No.	R-R-EHW-EMDCB
제조사/제조국가 Manufacturer/Country of Origin	EnOcean GmbH/독일
등록연월일 Date of Registration	2025-10-24
기타 Others	
위 기자재는 「전파법」 제58조의2 제3항에 따라 등록되었음을 증명합니다. It is verified that foregoing equipment has been registered under the Clause 3, Article 58-2 of Radio Waves Act.	
2025년(Year) 10월(Month) 24일(Day)	
 국립전파연구원장 Director General of National Radio Research Agency	
※ 적합등록 방송통신기자재는 반드시 "적합성평가표시" 를 부착하여 유통하여야 합니다. 위반시 과태료 처분 및 등록이 취소될 수 있습니다.	

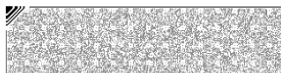

**EMDCB (REVISION DB)**BLUETOOTH LOW ENERGY MOTION DETECTOR AND LIGHT LEVEL SENSOR

---

**11.5.1 KC (Korea) product registration details**

PTM 216B has been registered for use in Korea with the following information:

- |                            |   |
|----------------------------|---|
| 1. End product ID:         | R-R-EHW-EMDCB   |
| 2. Product name and model: | Bluetooth Low Energy Motion Detector<br>And Light Level Sensor<br>EMDCB |
| 3. Applicant full name:    | EnOcean GmbH  |
| 4. Manufacturing date:     | As listed on the device label, see chapter 4.5                          |
| 5. Manufacturer full name: | EnOcean GmbH  |
| 6. Country of origin:      | Germany and Hungary   |

**11.5.2 KC (Korea) product registration logo**

The following logo documents the registration of EMDCB in Korea:

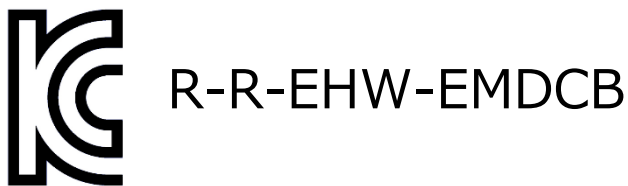

This logo shall be listed in the customer documentation of EMDCB.

**EMDCB (REVISION DB)**BLUETOOTH LOW ENERGY MOTION DETECTOR AND LIGHT LEVEL SENSOR

---

**12 License information**

This product contains TinyCrypt Cryptographic Library  
Copyright (c) 2017, Intel Corporation. All rights reserved.

Redistribution and use in source and binary forms, with or without modification,  
are permitted provided that the following conditions are met:

- Redistributions of source code must retain the above copyright notice, this list of conditions and the following disclaimer.
- Redistributions in binary form must reproduce the above copyright notice, this list of conditions and the following disclaimer in the documentation and/or other materials provided with the distribution.
- Neither the name of the Intel Corporation nor the names of its contributors may be used to endorse or promote products derived from this software without specific prior written permission.

THIS SOFTWARE IS PROVIDED BY THE COPYRIGHT HOLDERS AND CONTRIBUTORS "AS IS" AND ANY EXPRESS OR IMPLIED WARRANTIES, INCLUDING, BUT NOT LIMITED TO, THE IMPLIED WARRANTIES OF MERCHANTABILITY AND FITNESS FOR A PARTICULAR PURPOSE ARE DISCLAIMED.

IN NO EVENT SHALL THE COPYRIGHT OWNER OR CONTRIBUTORS BE LIABLE FOR ANY DIRECT, INDIRECT, INCIDENTAL, SPECIAL, EXEMPLARY, OR CONSEQUENTIAL DAMAGES (INCLUDING, BUT NOT LIMITED TO, PROCUREMENT OF SUBSTITUTE GOODS OR SERVICES; LOSS OF USE, DATA, OR PROFITS; OR BUSINESS INTERRUPTION) HOWEVER CAUSED AND ON ANY THEORY OF LIABILITY, WHETHER IN CONTRACT, STRICT LIABILITY, OR TORT (INCLUDING NEGLIGENCE OR OTHERWISE) ARISING IN ANY WAY OUT OF THE USE OF THIS SOFTWARE, EVEN IF ADVISED OF THE POSSIBILITY OF SUCH DAMAGE.

**EMDCB (REVISION DB)**

BLUETOOTH LOW ENERGY MOTION DETECTOR AND LIGHT LEVEL SENSOR

---

**13 Product history**

Table 6 below lists the product history of EMDCB.

<b>Revision</b>	<b>Release date</b>	<b>Key changes versus previous revision</b>
CA-01	December 2018	First release for lead customers
CA-02	June 2019	Addition of 2 Mbit mode
DA-04	December 2019	Addition of adaptive reporting via solar cell and light sensor
DB-09	August 2024	All functional modes now selectable via NFC Change from single-color to bi-color LED

**Table 6 – Product History**

**EMDCB (REVISION DB)**

## BLUETOOTH LOW ENERGY MOTION DETECTOR AND LIGHT LEVEL SENSOR

**A Receiver configuration**

EMDCB transmits sensor information as a set of advertising events either on the BLE advertising channels or on user-defined radio channels as described in chapter 5.

In order to maximize the likelihood of reception of these telegrams, it is necessary that the receiver is either permanently in receive mode on one of the radio channels used by EMDCB or – if this is not possible – periodically in receive mode for a sufficiently long duration.

**A.1 Scanning parameters**

Three key timing parameters have to be considered when configuring a receiver (scanner) for periodical reception of advertising events sent by a transmitter (advertiser). These three parameters are:

- Advertising interval  
Time between two advertising events sent by the transmitter
- Scan interval  
Time between the start of two consecutive scanning cycles of the receiver
- Scan window  
Duration for which the receiver will scan within each scanning cycle

Figure 28 below illustrates these three parameters.

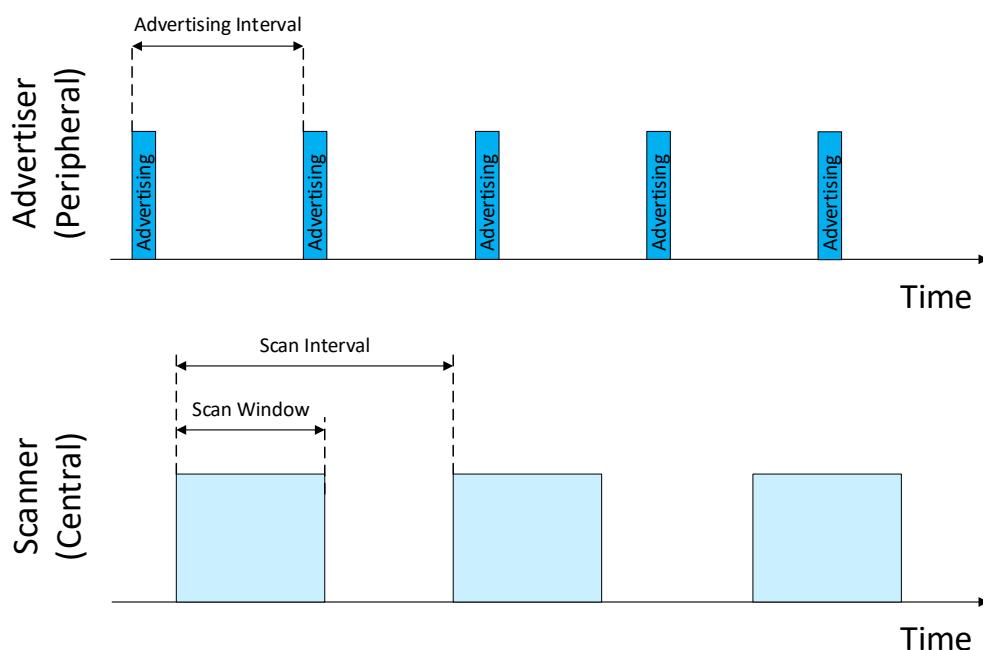

**Figure 28 – Scanning parameters**

**EMDCB (REVISION DB)**BLUETOOTH LOW ENERGY MOTION DETECTOR AND LIGHT LEVEL SENSOR

---

**A.1.1 Advertising interval**

EMDCB transmits advertising events with an advertising interval of either 20 ms (default setting) or 10 ms (NFC configurable setting).

The time required to transmit each advertising telegram within the advertising event is approximately 0.5 ms and the time required to transmit the entire advertising event (transmission of three advertising telegrams on three different radio channels including radio channel change) is approximately 2.5 ms.

**A.1.2 Scan window**

The scan window has to be selected such that the receiver will under all conditions receive at least one full advertising telegram.

To ensure this requirement, we consider the worst-case condition where the receiver starts scanning directly after the start of one transmission and therefore misses a part of it. Under these conditions, it is necessary that the receiver remains active until the next advertising telegram has been fully transmitted. This is illustrated in Figure 29 below.

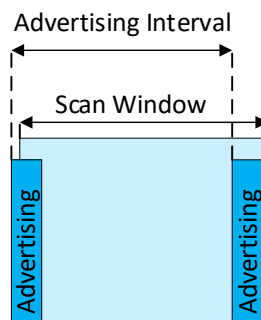

**Figure 29 – Scan window setting**

From Figure 29 above it can be seen that the minimum duration of the scan window is dependent on the advertising interval:

- If EMDCB uses 20 ms advertising intervals, then the scan window has to be at least 20 ms (advertising interval) plus 0.5 ms (telegram duration) plus a timing margin to account for the random time offset at the transmitter. Using a scan window of at least 23 ms is recommended for this case.
- If EMDCB uses 10 ms advertising intervals, then the scan window has to be at least 10 ms (advertising interval) plus 0.5 ms (telegram duration) plus a timing margin to account for the random time offset at the transmitter. Using a scan window of at least 13 ms is recommended for this case.

**EMDCB (REVISION DB)**

BLUETOOTH LOW ENERGY MOTION DETECTOR AND LIGHT LEVEL SENSOR

**A.1.3 Scan interval**

The scan interval has to be selected such that the receiver will not be inactive so long that it misses all three advertising events.

The longest period for which the receiver can be inactive is given by the time between the end of the first advertising events (assuming that the receiver exactly misses the last bit of it) and the beginning of the third advertising event (so that this will certainly be received). Figure 30 illustrates this.

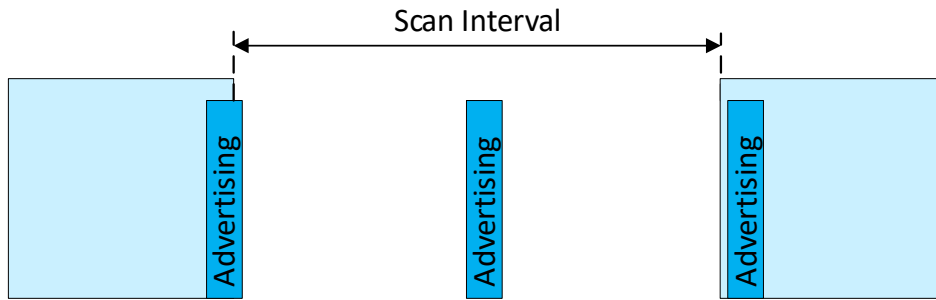

**Figure 30 – Scan interval setting**

From Figure 30 above it can be seen that the maximum duration of the scan interval is dependent on the advertising interval:

- If EMDCB uses 20 ms advertising intervals, then the scan interval has to be less than the time between the end of the first advertising event and the begin of the third advertising event ( $2 * 20 \text{ ms} = 40 \text{ ms}$ ) minus 0.5 ms (telegram duration) minus a timing margin to account for the random time offset at the transmitter. Using a scan interval of no more than 37 ms is recommended for this case.
- If EMDCB uses 10 ms advertising intervals, then the scan interval has to be less than the time between the end of the first advertising event and the begin of the third advertising event ( $2 * 10 \text{ ms} = 20 \text{ ms}$ ) minus 0.5 ms (telegram duration) minus a timing margin to account for the random time offset at the transmitter. Using a scan interval of no more than 17 ms is recommended for this case.

**A.1.4 Summary**

Table 7 below summarizes the recommended receiver scan settings.

<b>EMDCB Advertising Interval</b>	<b>Receiver Scan Window (Minimum)</b>	<b>Receiver Scan Interval (Maximum)</b>
10 ms	23 ms	37 ms
20 ms	13 ms	17 ms

**Table 7 – Recommended receiver scan settings**